

**Vending machine**

**ACCESSORIES AND PAYMENT SYSTEMS**

**D.A. COMBISNACK**



Type: D.A. COMBISNACK

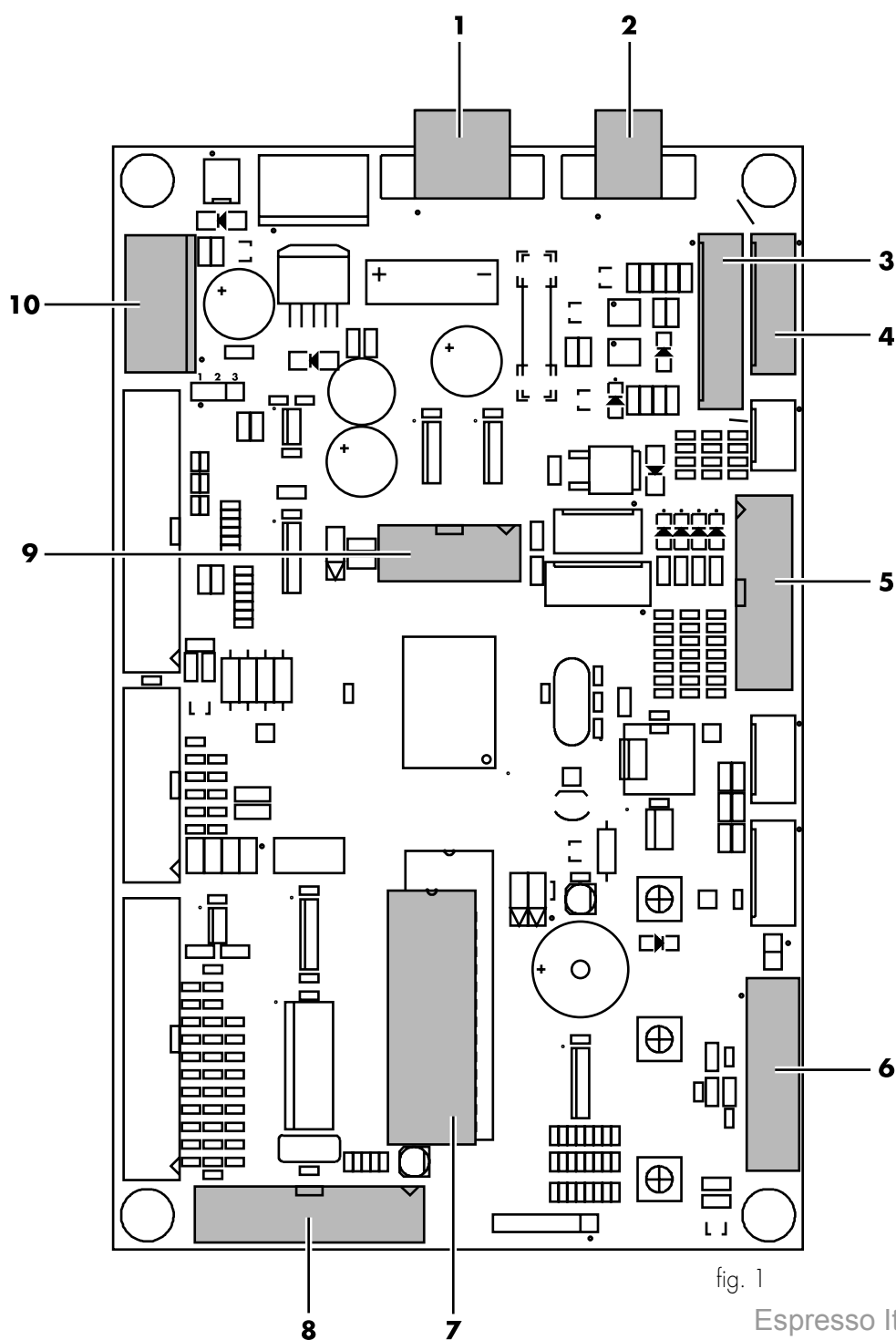
**USE AND MAINTENANCE**

# Contents

<b>1 - DIAGRAM OF CONNECTIONS TO THE KEYPAD BOARD/CPU:</b>	3
<b>2 - PAYMENT SYSTEM INSTALLATION</b>	4
<b>3 - PAYMENT SYSTEM FEEDER KIT</b>	5
<b>4 - INDEPENDENT TANK KIT</b>	7
<b>5 - FLOAT KIT</b>	10
<b>6 - PULSE COUNTER KIT</b>	12
<b>7 - WATER SOLENOID VALVE KIT</b>	13
<b>8 - SUGAR COIL KIT</b>	15
<b>9 - SAECO CARD ASSEMBLY KIT</b>	17
9.1 - Saeco card programming	19
<b>10 - HANDLING KIT</b>	20
<b>11 - BRITA PURIFIER KIT</b>	21
<b>12 - RS 232 INTERFACE BOX</b>	23
<b>13 - SAECO WATER SOFTENER SUPPORT</b>	24
<b>14 - PROGRAMMING KEY</b>	25
<b>15 - 12V PARALLEL COINER KIT</b>	25
<b>16 - CLOCK MODULE INSERTION (TIME KEEPER)</b>	26
16.1 - TIME KEEPER functions in the programming menus	26
16.2 - TIME KEEPER functions in the maintenance menus	27

## 1 - DIAGRAM OF CONNECTIONS TO THE KEYPAD BOARD/CPU:

1. MDB systems;
2. BDV, MDB and executive system power supply;
3. 24 V DC / 12 V DC banknote reader;
4. Executive and BDV systems;
5. 24 V DC parallel coiner (non-change giving);
5. 12 V DC parallel coiner (non-change giving) with its suitable kit,
6. Programming key;
7. Clock module;
8. Saeco card;
9. Connector for PC serial interface
10. Feeder kit for payment systems;





### Maintenance technician

It is used to indicate operations to be performed by specialized maintenance technicians only.

He is the only person authorized to keep the **KEY TO ACTIVATE THE SAFETY MICROSWITCH** which allows disabling the security system.

## 2 - PAYMENT SYSTEM INSTALLATION

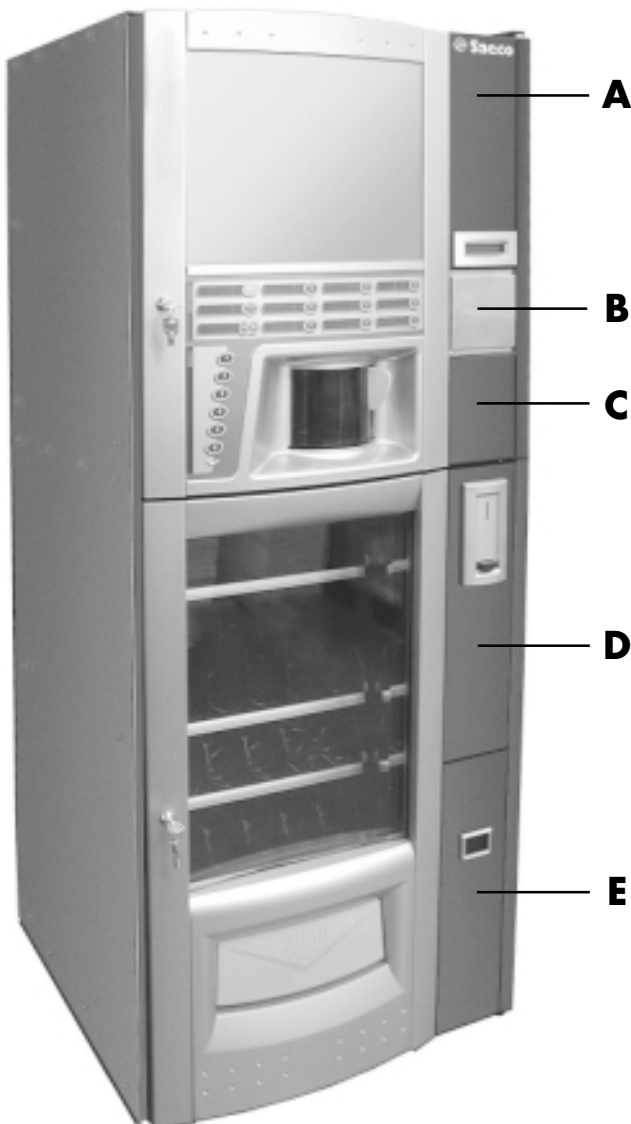


fig. 2

This vending machine is supplied with panels assembled as shown in fig. 2. It is possible to change and replace them with those provided by Saeco according to the customer's requirements.

- Panel for OTR. and M.IVO banknote readers
- Panel for JCM banknote reader
- Panel for SMILE banknote reader
- Panel for m125 COINCO banknote reader
- Panel for NRI G13 coiner
- Lower Neutra panels (to combine with NRI G 13 panel)

Saeco also supplies the relevant wiring harnesses to connect the different payment systems.

A specific kit must be used to connect the 12V non-change-giving parallel coiner.

Open the front doors to replace the panels and remove the CPU guard to replace the upper door.

Before taking panel B off, it is necessary to remove also the instruction support steel sheet.

### Panel for OTR. and M.IVO banknote readers

It is inserted in lieu of panels B, C and is preset for OTR. and M.IVO banknote readers.

### Panel for JCM banknote reader

It is inserted in lieu of panels B, C and is preset for JCM banknote reader.

### Panel for SMILE banknote reader

It is inserted in lieu of panels B, C and is preset for SMILE banknote reader.

### Panel for m125 COINCO banknote reader

It is inserted in lieu of panels B, C and is preset for m125 COINCO banknote reader.

### Panel for NRI G13 coiner and Neutra lower panel

These two panels must be combined.

They are inserted in lieu of panels D, E and are preset for NRI G13 COINER.

- Connect the payment system cable to the suitable connector on the CPU card according to the instructions supplied by the diagram at page 3.

- If during the payment system installation, the "B" panel instructions are removed, it will be necessary to insert the proper instructions, in a large, short format, in the "advertising image" area.

### 3 - PAYMENT SYSTEM FEEDER KIT



This kit provides all the necessary power supply for the proper operation of the payment systems connected to the CPU card of Combisnack vending machine, which have a mains voltage of + 12 Vdc (parallel banknote readers) or + 6 Vdc (1432.0xx and 1471.0xx models saeco card).

#### Assembly kit (fig. 3)

- a. 1 feeder outlet wiring harness - CPU card
- b. 4 screws and spacers
- c. 1 feeder inlet wiring harness - CPU card
- d. 1 +6Vdc / +12Vdc feeder board

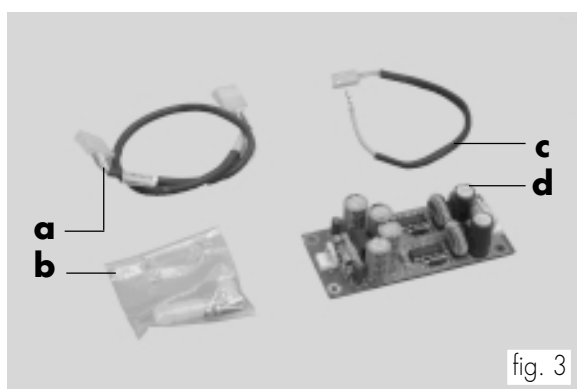


fig. 3

#### Installation

- Open the upper door and fasten (fig. 4) the payment system power supply board (ref. d, fig. 3) to the same door by using the four screws and spacers (ref. b, fig. 3).



fig. 4

- Connect the wiring harness (ref. a, fig. 3) to the payment system power supply board as well as to the CPU card (fig. 5). See instructions on harness to carry out the connection.

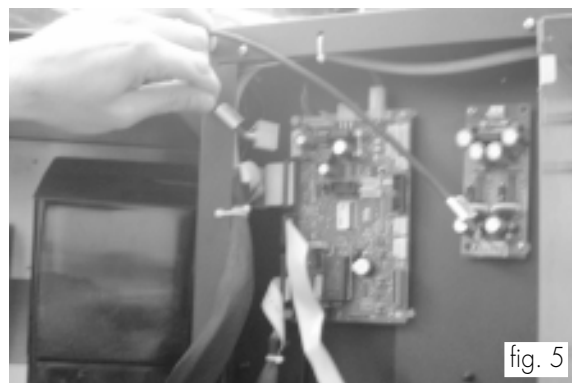


fig. 5

- Unplug the four-pin connector from the CPU card (fig. 6).

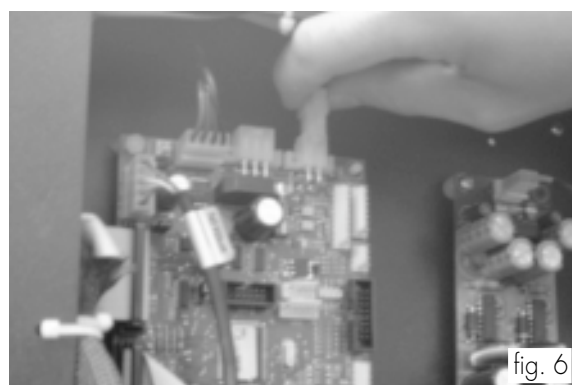


fig. 6

- Connect the two-pin connector (ref. c, fig. 3) to the payment system power supply board. Connect the 2 contacts of the other end to the 2 free slots of the 4-pin connector that was previously unplugged from the CPU card (fig. 7).



fig. 7

- Connect the four-pin connector to the CPU card (fig. 8).



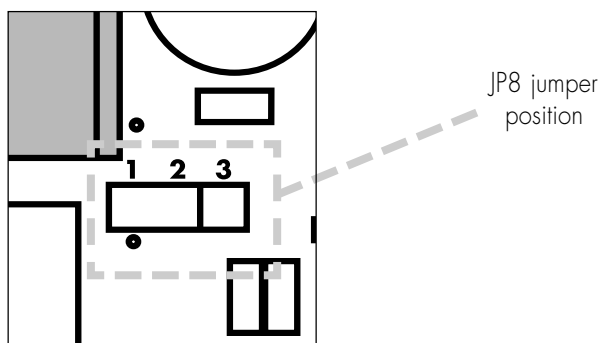
- Close the vending machine upper door.

The mains voltage values provided by this feeder can also be found on CN6 (ref. **3**, fig. 1) and CN9 (ref. **8**, fig. 1) connectors of CPU card.

Connector	Description	Voltage	Pin
CN6	connector for parallel banknote readers	+12Vdc	7
CN9	connector for saeco card universal module	+5Vdc or +6Vdc (see table below)	12,13,14

Pin 12, 13, 14 voltage of CN6 is set according to JP8 jumper position.

JP8 jumper position	Voltage on CN6 12, 13, 14 pins
1-2	+6Vdc
2-3	+5Vdc



## 4 - INDEPENDENT TANK KIT

This kit allows the vending machine to be supplied by means of an internal tank instead of by the water network. To do this, it is necessary to use the tank inside the machine as drinking water hopper. If the machine has not been started for the first time, and the tank has already been used as discharge fluid tank, it shall be replaced with a new one.

### Assembly kit (fig. 9)

- a. 1 discharge fluid tank with cap
- b. 1 spring for tank
- c. 1 pump with supports and pipe fitting
- d. 1 pump wiring harness
- e. 1 pump feeding wiring
- f. 1 cap for spout
- g. 1 water inlet pipe
- h. 4 screws and washers (two of them measure 4,3x12 and the other two 4,3x16)
- i. 1 perforated cap
- m. 1 cap for spout
- n. 1 KAPSTO GPN 350 dia 30 cap
- p. 1 PVC drain tube
- r. 1 relay with support plate

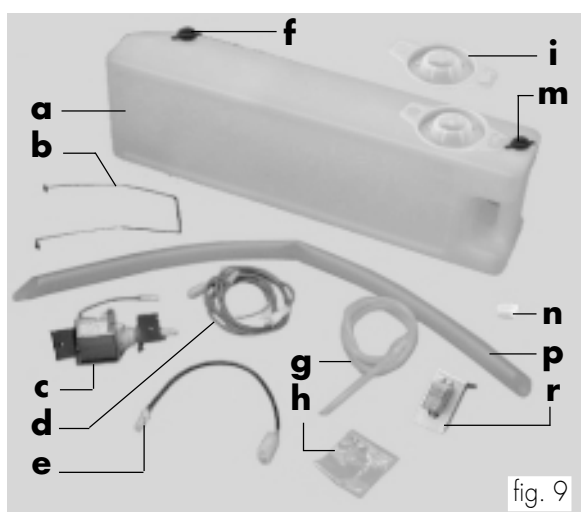


fig. 9

### Installation

- Remove the machine rear panel (fig. 10) by untightening the screws and disconnecting the ground wiring placed on the machine.



fig. 10

- Open the upper door and take out the retaining spring from the left hand pipe (fig. 11).

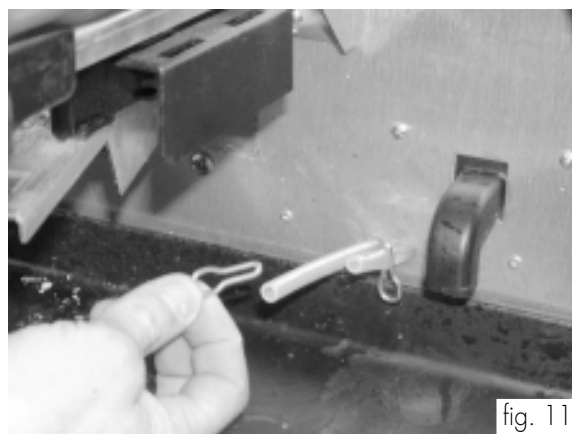


fig. 11

- Disconnect the two pipes from the water inlet solenoid valve (fig. 12)

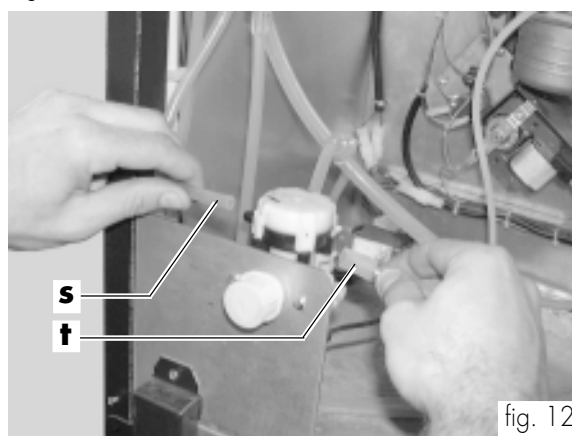


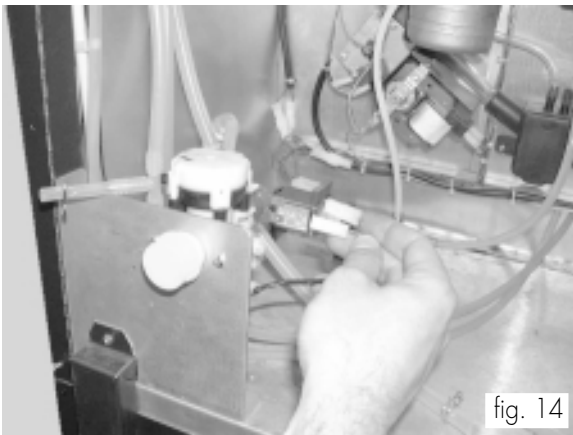
fig. 12

- Apply the pipe retaining spring (see fig. 11) on the silicone pipe (ref. t, fig. 12) fitted on "T" and previously removed from the inlet solenoid valve (fig. 13).

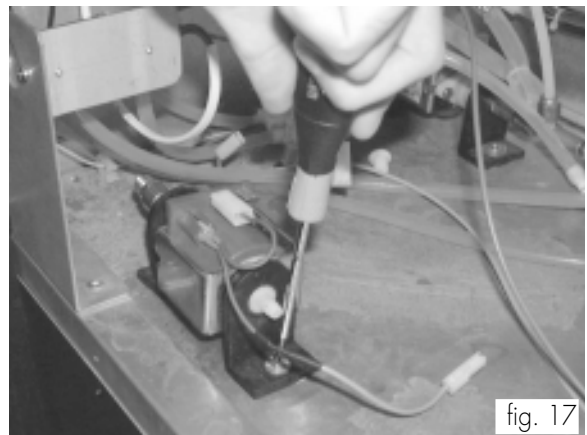


fig. 13

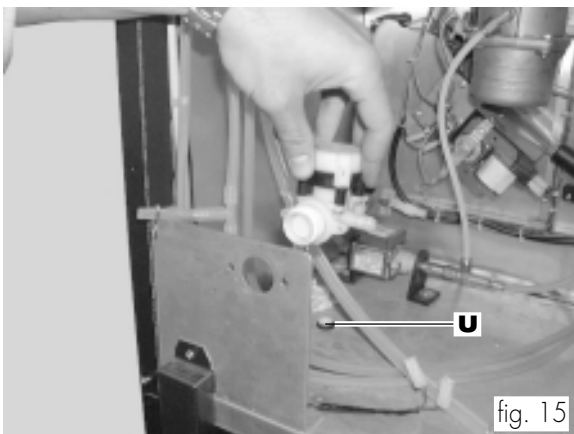
- Disconnect the two power supply wirings from the water inlet solenoid valve (fig. 14).



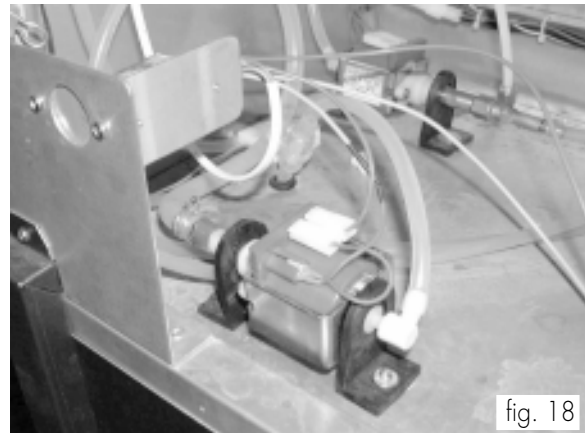
- Tighten the pump by means of the two screws and two washers 4,3x16 (ref. **h**, fig. 9) to the bottom (fig. 17).



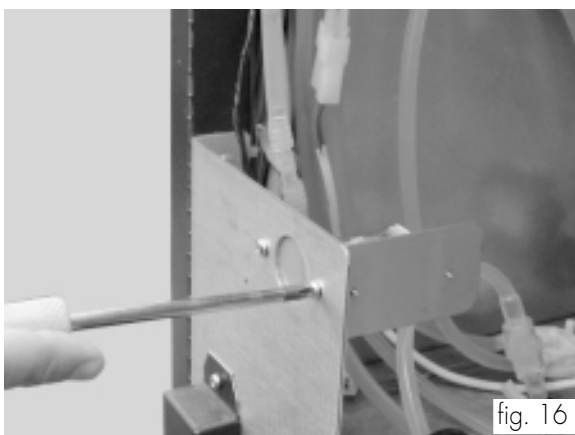
- Remove the water inlet solenoid valve (fig. 15).



- Connect the pipe (ref. **s**, fig. 12), previously extracted from the water inlet solenoid valve, to the fitting located on the pump (fig. 18).
- Withdraw the cap (ref. **u**, fig. 15). Connect the water inlet pipe to the pump. Move the other end of the pipe to the lower part of the vending machine passing through the hole (ref. **u**, fig. 15)



- Tighten the relay and support plate (ref. **r**, fig. 9) by using the screws previously taken from the inlet solenoid valve (fig. 16)



- Carry out all the electric connections as indicated by the diagram below.



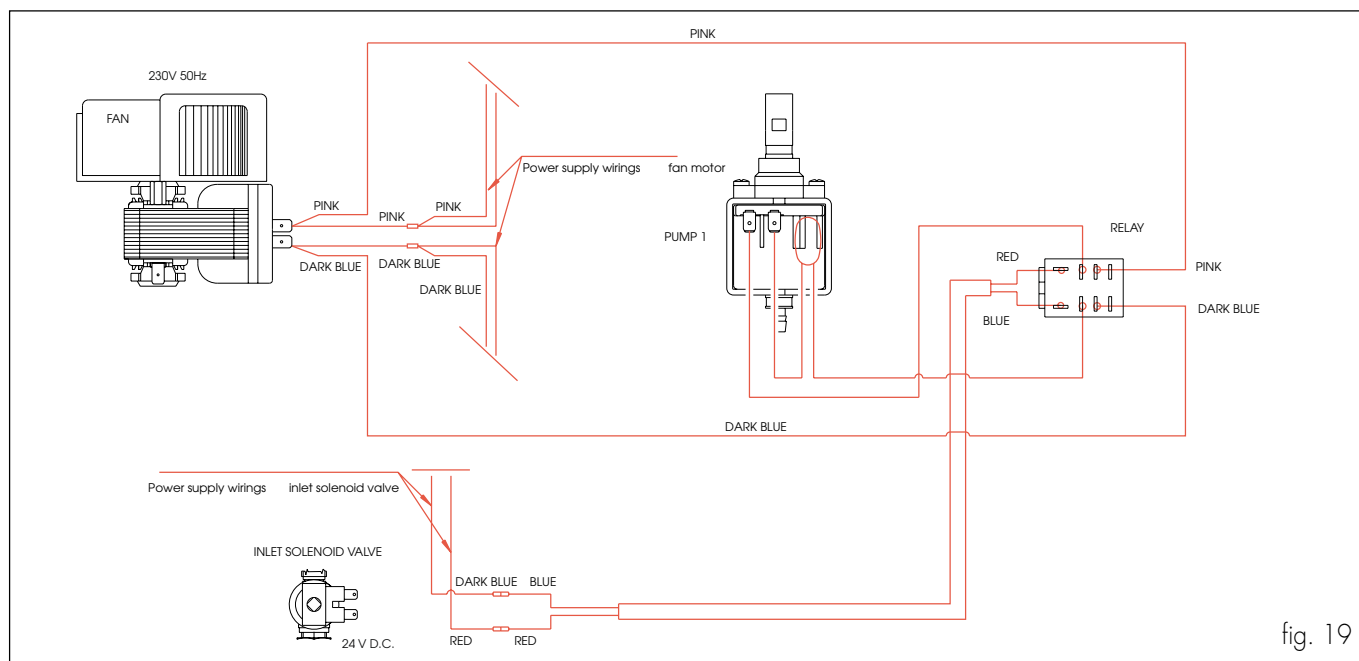


fig. 19

- Reassemble the machine rear panel taking care to reconnect the earth cable.
- Open the V.M. lower door.
- Tighten the spring (ref. **b**, fig. 9) in the position shown in fig. 29 by using the two screws and two washers 4,3x12 (ref. **h**, fig. 9).



fig. 20

- Insert the pipe (ref. **g**, fig. 23) in the perforated cap of the drinking water tank.
- Fill the drinking water tank.



fig. 23

- Replace the pipe fastened to the drain channel (fig. 21) with the drain tube (ref. **p**, fig.9). Remove the cap (ref. **m**, fig. 9) from the tank. Insert the other end of the pipe in the discharge fluid tank (fig. 22). Make sure that the other tank holes are properly capped.



fig. 21



fig. 22

- Fit the cap on the tank. Place the tank inside the V.M. (fig. 24) by sliding the pipe inside the tank itself. Close the hole (ref. **v**, fig. 23) by means of the cap (ref. **n**, fig. 9).



fig. 24



### Important

Before removing the tank to empty it, close the pipe hole using the relevant cap (ref. **m**, fig. 9). This will help preventing any liquid spillage due to the surge effect.

- Close the vending machine lower door.

## 5 - FLOAT KIT

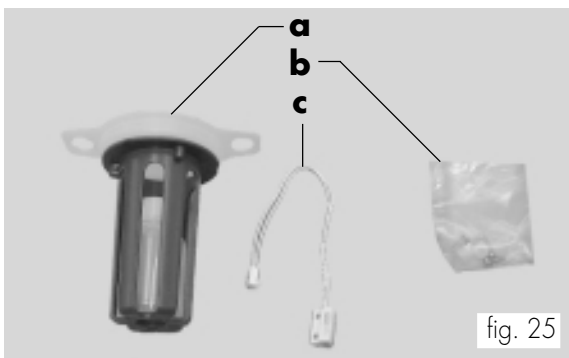


It allows the display to read the discharge fluid maximum level. In this condition, no hot beverage is available and the display will read "ERROR 09".

The float can be installed in different positions according to whether the machine is connected to a water network (22 L tank) or uses an independent tank (7L tank).

### Assembly kit (fig. 25)

- a. 1 basket set for discharge fluid level
- b. 2 screws
- c. 1 reed wiring

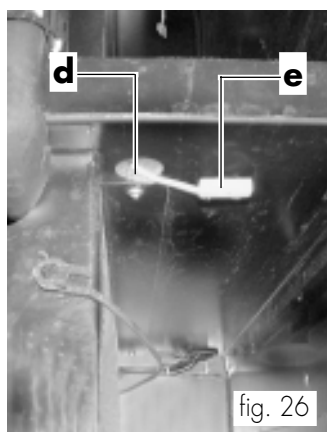


### Important

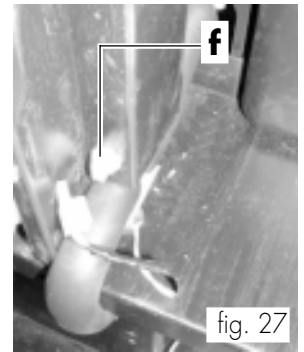
When assembling the lower level sensor (fig. 26) disconnect the higher sensor (fig. 30). The drain level control system doesn't work if two sensors are connected.

### Installation

- Open the front lower door.
- If it is applied on the independent tank version, it is necessary to remove the 7 L tank (ref. g, fig. 28) and to assemble the reed wiring (ref. c, fig. 25) by means of the two screws (ref. b, fig. 25) according to the position shown in the figure (ref. e, fig. 26).



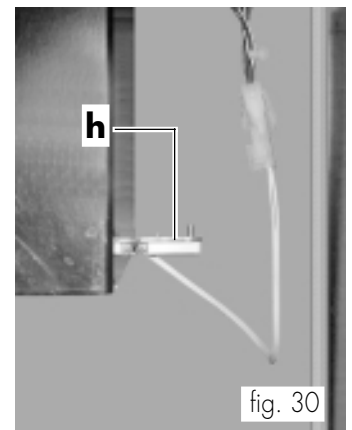
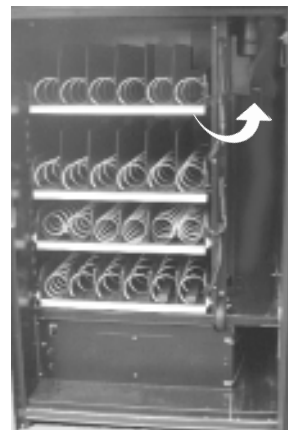
- Slide the other end of the reed wiring inside the hole (ref. d, fig. 26) and couple it to the connector (ref. f, fig. 27).



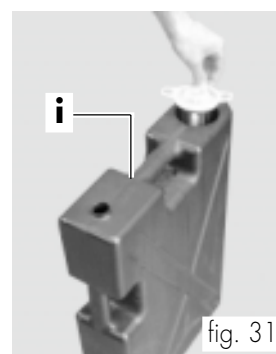
- Remove the tank cap (fig. 28) and replace it with the discharge level basket set (fig. 29).



- Reinstall the tank.
- If it is applied to the water network version, it is necessary to remove the 22L tank (ref. i, fig. 31) and to fit the reed wiring (ref. c, fig. 25) by means of the two screws (ref. b, fig. 25) on the square (ref. h, fig. 30). Then, couple the other end to the connector (fig. 30).



- Remove the tank cap (fig. 31) and replace it with the discharge level basket set (fig. 32).



- Reinstall the tank.

Access the machine programming menu and set "YES" in the "TANK" menu (fig. 34) to enable the display reading of the discharge fluid maximum level.

In order to properly carry out this operation, disable the safety device and press key 1 (fig. 33) to access the programming menu.

If no password has been assigned you enter the programming menu directly.

### Important

If vending machine was assigned a password to enable the programming menu, "PASSWORD 0000" will appear on display with a flashing cursor on the first digit.

Now digit the password using **UP** and **DOWN** keys. Confirm the entered digit by means of **ENTER** key.

To exit the programming menu and return to the normal operation of the vending machine:

- press key 1 again;
- remove the key from the safety switch to turn off the vending machine;
- close the door and wait for the self-configuration process to end.

### Important

When the tank maximum level is reached, the display will read "HOT BEVERAGES NOT AVAILABLE" (ERROR 09 code). In this condition, the V.M. cannot brew hot beverages. It is therefore necessary to empty the tank. After emptying the tank, the error message will automatically disappear at the machine switching on.

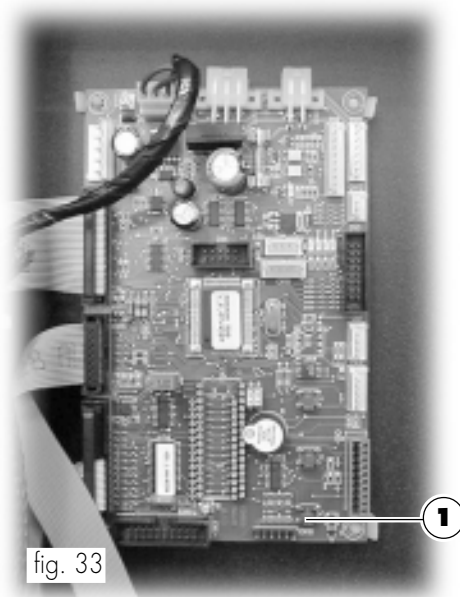


fig. 33

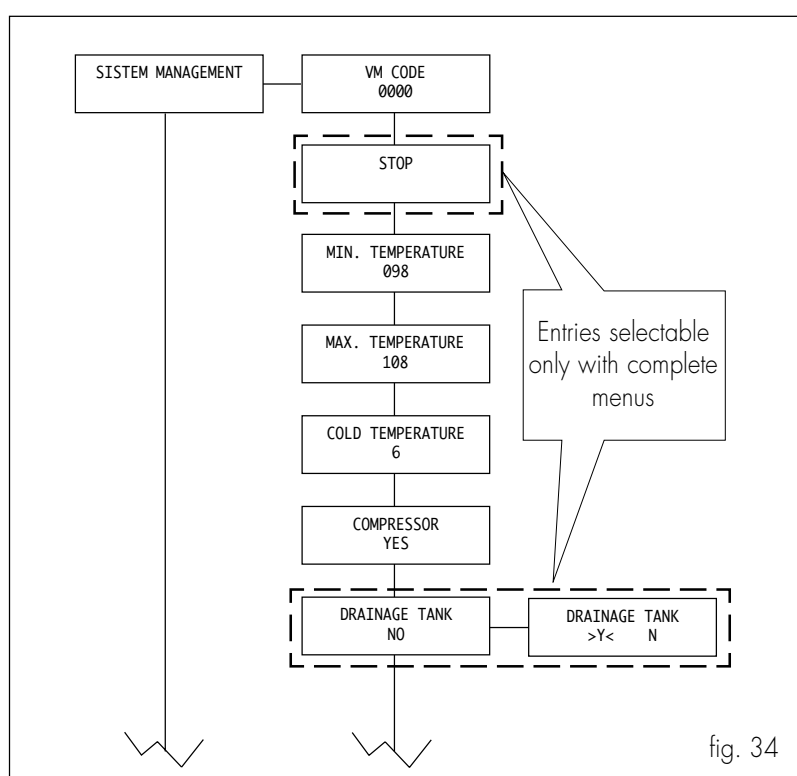


fig. 34

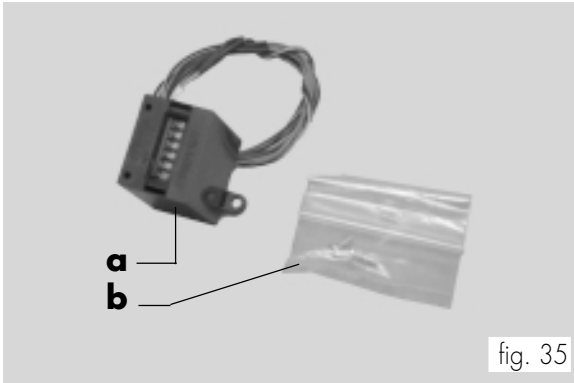
## 6 - PULSE COUNTER KIT



The vending machine can be fitted with an electromechanical pulse counter (24V DC) which will count the number of coffees or the total beverages brewed by the machine.

### Assembly kit (fig. 35)

- a. 1 pulse counter with support
- b. 2 screws



### Installation

- Open the upper door and fasten the pulse counter (ref. a, fig. 35) to it (fig. 36) by means of the two screws (ref. b, fig. 35).



- Couple the pulse counter wiring with the "CN14" connector of the board (fig. 37).



To enable the counting of coffees or beverages brewed, access the machine programming menu and set "COFFEE" or "BEVERAGES" in the "PULSE COUNTER" menu (fig. 38).

In order to properly carry out this operation, disable the safety device and press key 1 (fig. 33) to access the programming menu.

If no password has been assigned you enter the programming menu directly.

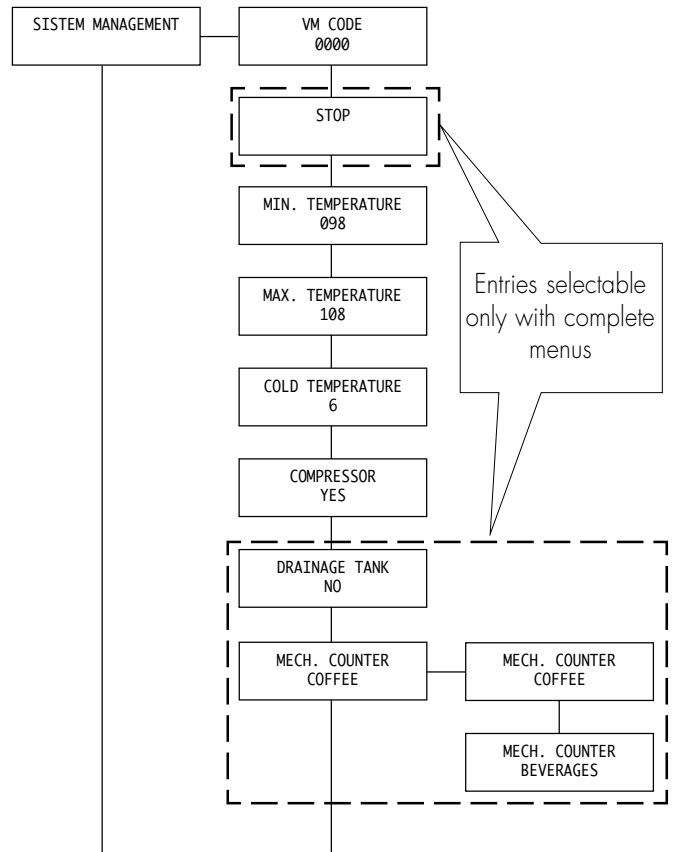
### Important

*If vending machine was assigned a password to enable the programming menu, "PASSWORD 0000" will appear on display with a flashing cursor on the first digit.*

*Now digit the password using **UP** and **DOWN** keys. Confirm the entered digit by means of **ENTER** key.*

To exit the programming menu and return to the normal operation of the vending machine:

- press key 1 again;
- remove the key from the safety switch to turn off the vending machine;
- close the door and wait for the self-configuration process to end.



## 7 - WATER SOLENOID VALVE KIT



It is possible to brew hot water alone by installing the required kit

### Assembly kit (fig. 39)

- a. 1 water pipe set
- b. 1 OR, pipe clamp and 1/8" H4,5 nut
- c. 1 two-way solenoid valve

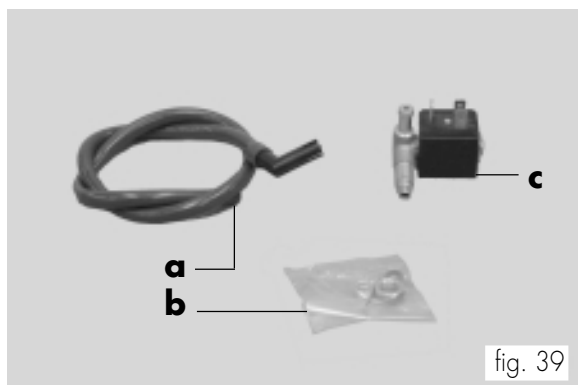


fig. 39

### Installation

- Remove the machine rear panel (fig. 40) by untightening the screws and disconnecting the ground wiring placed on the machine.



fig. 40

- Unscrew the cap inserted on the solenoid valve block (fig. 41) and hold the latter to avoid any excessive stress to the block support plate.



fig. 41

- Open the upper door and loosen the screw (fig. 42) fixing the block support plate.



fig. 42

- Remove the hopper (Fig. 43).



fig. 43

- Loosen the two screws fixing the block support plate (fig. 44).



fig. 44

- Screw the nut and fix the OR (ref. b, fig. 39) on the 2-way solenoid valve (ref. c, fig. 39). Remove the block support from its seat and screw the solenoid valve in the hole (fig. 45) previously cleared from its cap (fig. 41). The solenoid valve must be placed with fastons upwards. Reinstall the block support in their seat and tighten the screws.

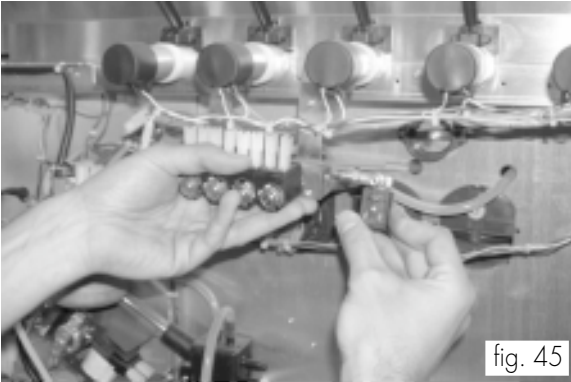


fig. 45

- Insert the pipe clamp (ref. b, fig. 39) on pipe (ref. a, fig. 39). Then, fasten the pipe (fig. 48) at the solenoid valve outlet and position the pipe retaining spring. Slide the other end of the pipe inside the assembly plate passage hole (ref. d, fig. 48).
- Reassemble the machine rear panel.

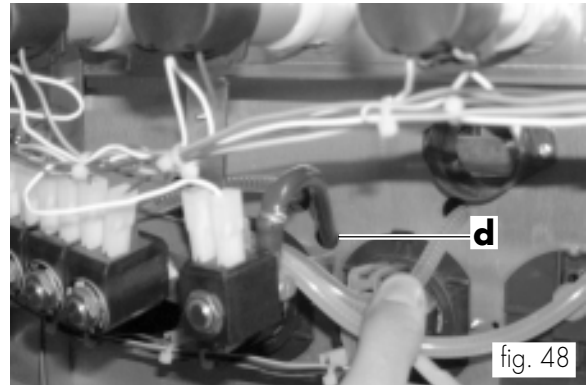


fig. 48

- Remove the clamp (fig. 46) that fastens the two unused cables.

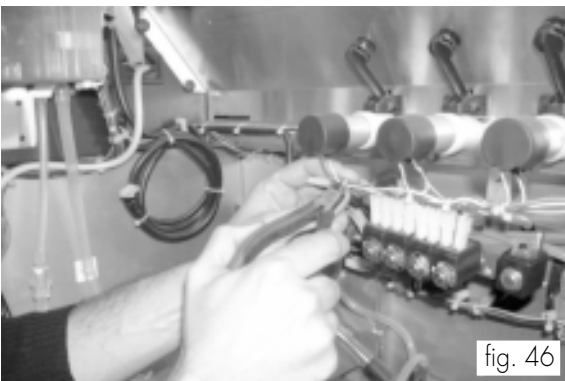


fig. 46

- Fasten the pipe end with fitting to the spout (fig. 49).



fig. 49

- Connect the 2 free cables to the solenoid valve taking care to insert the red cable on the left and the white cable on the right.



fig. 47

To brew hot water alone, it is necessary to set the beverage associated with the required key according to the following parameters:

Parameter	Value
Sequence	0001
Soluble product quantity 1	0
H2O soluble product quantity 1	Set the required water quantity
% soluble 1	100
sugar	0

- Close the vending machine upper door.

## 8 - SUGAR COIL KIT



This kit allows the sugar door opening only when required, since an electromagnet controls it. This prevents any sugar grain from accidentally falling when the “without sugar” option has been selected.

### Assembly kit (fig. 50)

- a.** 1 two-pin connector
- b.** 1 connecting rod
- c.** 2 M3x6 screws, 1 M3x8 screw and 1 M3 nut
- d.** 1 relay electromagnet
- e.** 1 spring
- f.** 1 sticker

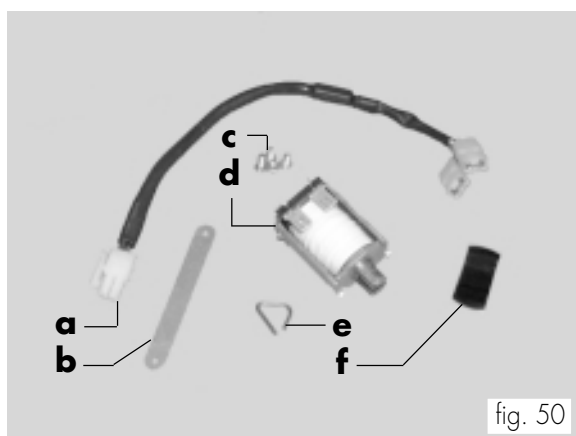


fig. 50

### Installation

- Open the upper front door.
- Remove the sugar-dispensing channel by opening the screw (ref. g, fig. 51).

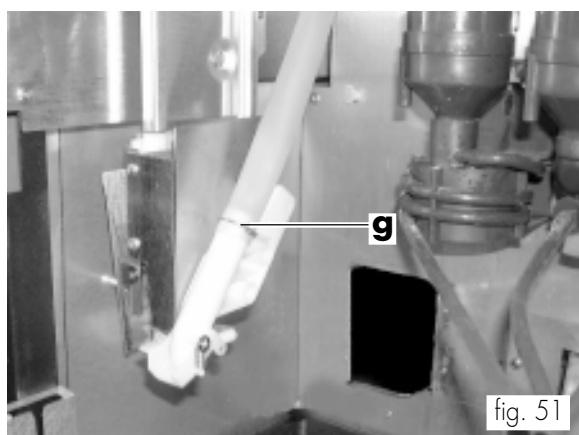


fig. 51

- Disassemble the sugar-dispensing channel (Fig. 52).

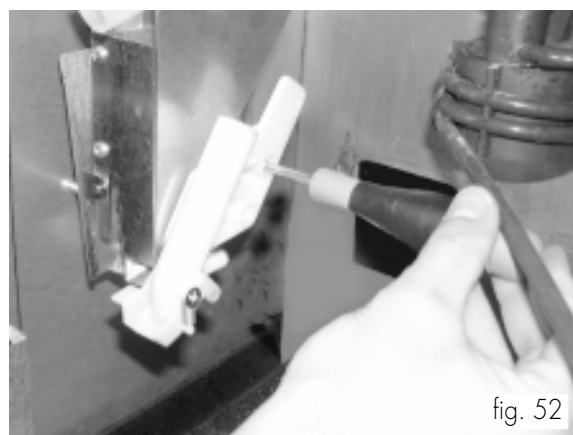


fig. 52

- Install the connecting rod (ref. b, fig. 50) on the electromagnet piston (ref. d, fig. 50) by means of the spring (ref. e, fig. 50) to obtain the unit shown in fig. 53.
- Apply the sticker (ref. f, fig. 50) to the electromagnet (fig. 54) in order to seal the hole located on the machine housing.



fig. 53



fig. 54

- Assemble this unit (see fig. 54) on the sugar channel (fig. 55) by means of two M3x6 screws (ref. c, fig. 50).

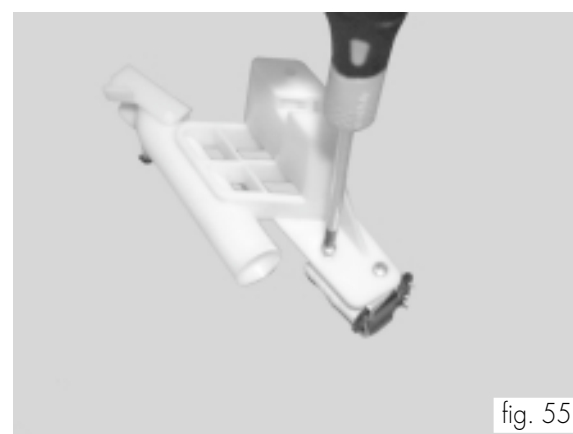
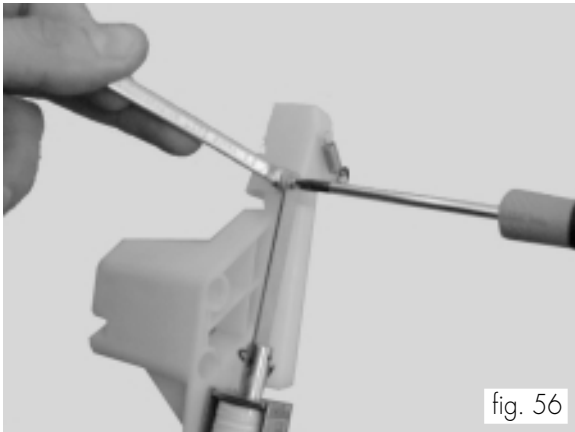
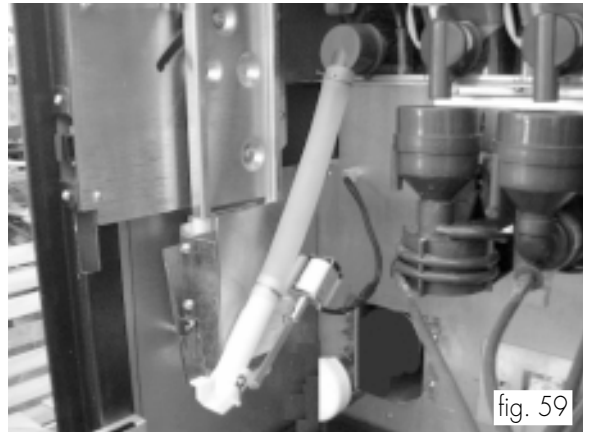


fig. 55

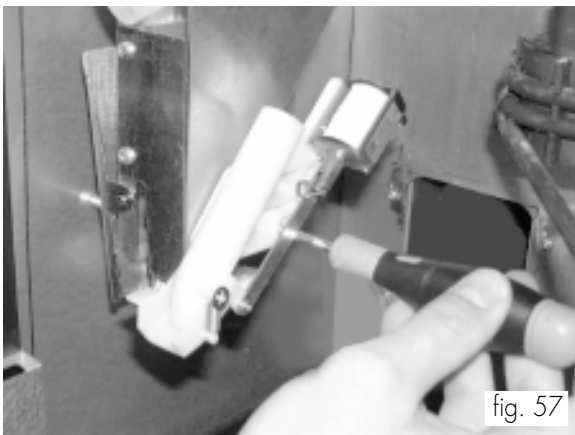
- Fasten the connecting rod on the sugar door (fig. 56) by means of an M3x8 screw and an M3 nut (ref. c, fig. 50).



- Reinstall the sugar channel and fix it with the spring (fig. 59).



- Assemble the whole unit on the sugar stirrer dispenser (fig. 57)



- Close the vending machine upper door.

- Couple the connector (ref. a, fig. 50) with the electromagnet by means of the fastons. Insert the other end in the connection located on the mounting plate (fig. 58).





## 9 - SAECO CARD ASSEMBLY KIT

### Assembly kit (fig. 60)

- a. 1 adhesive sheet for drilling
- b. 1 guard for universal module
- c. 1 flat cable
- d. 4 screws and 4 spacers for card
- e. 1 Saeco card external antenna

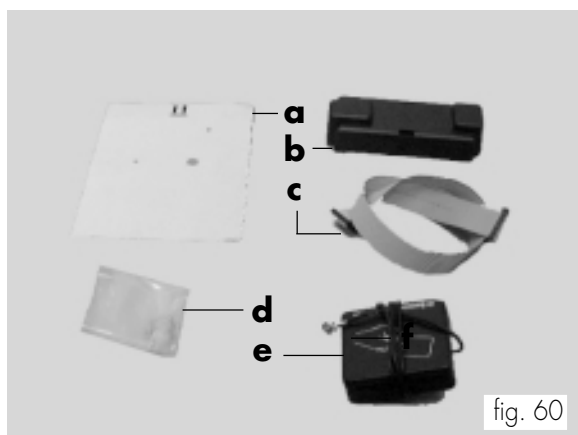


fig. 60



#### Important

To use the Saeco card, the machine must be equipped with a Time keeper.



#### Important

If the universal module to be mounted has a 1432.0xx or 1471.0xx code, it will be necessary to use a payment system feeder kit.

### Installation

- Place the adhesive sheet (ref. a, fig. 60) on the lower tile (fig. 61). Drill according to the diagram on sheet using a 3 dia. point for the two small holes and a 10 dia. point for the other hole.



fig. 61

- Open the upper front door.
- Loosen the guard fastening screws and remove it (fig. 62).



fig. 62

- Remove the two screws (fig. 63) of the external antenna; they will be subsequently used to fasten the antenna to the tile.

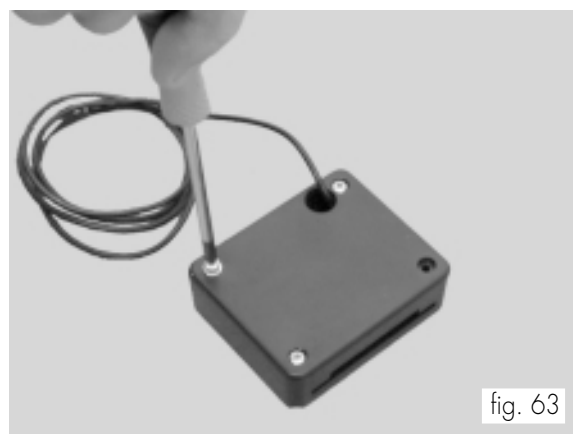


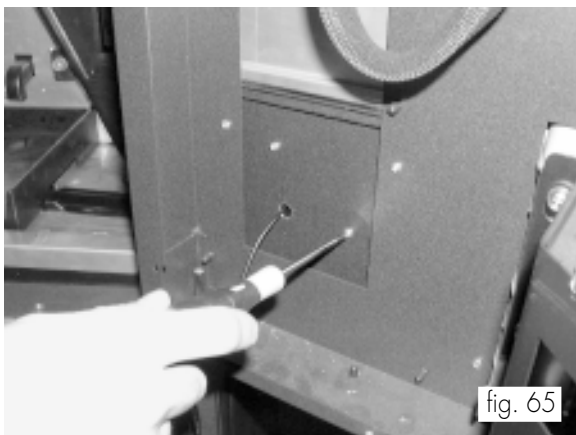
fig. 63

- Fasten the antenna on the tile (fig. 64) by sliding the cable through the 3 dia. hole.

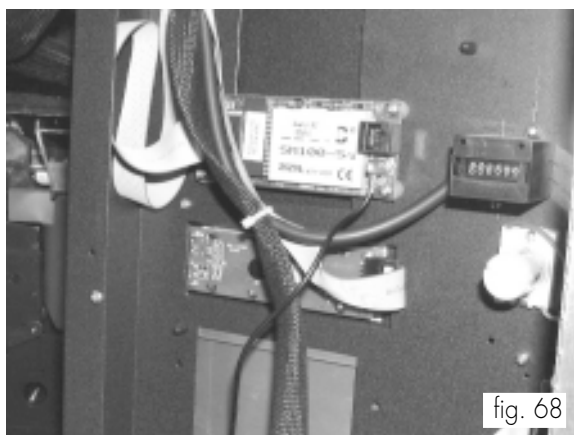


fig. 64

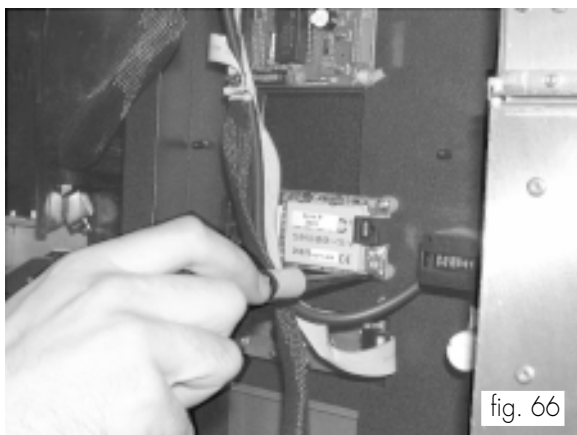
- Tighten the two screws (fig. 65).



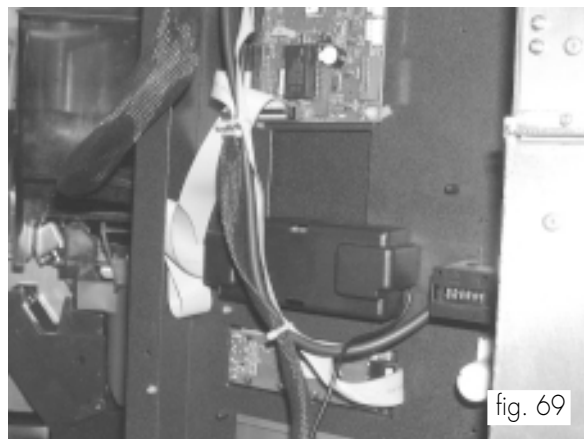
- Connect the antenna cable to the universal module (fig. 68).



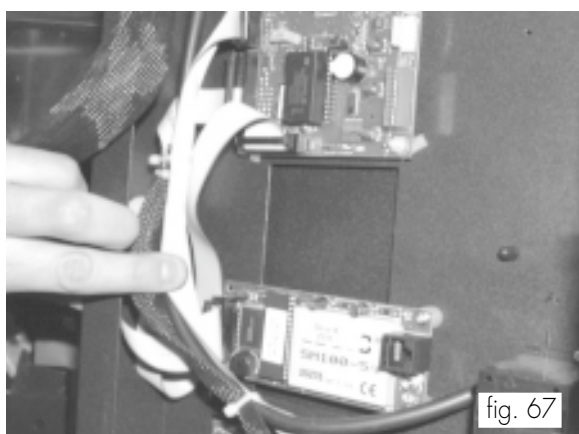
- Fasten the universal module by means of the 4 screws and spacers (ref. d, fig. 60) on the door (fig. 66).



- Assemble the guard (ref. b, fig. 60) on the universal module (fig. 69).

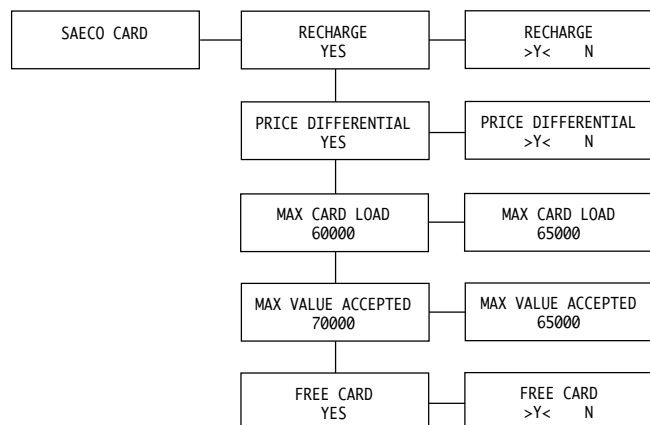


- Connect the universal module to the I/O card (fig. 67) by means of the flat cable (ref. c, fig. 60).



## 9.1 - Saeco card programming

The Saeco card module presence (automatically detected by the V.M.) adds the following entries to the PAYMENT SYSTEM programming menu



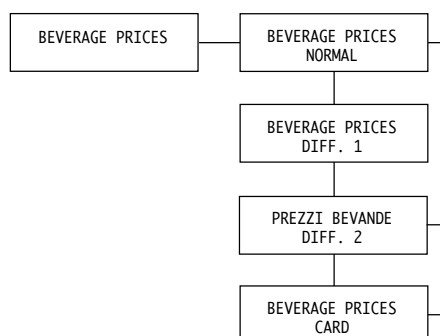
Entry description:

### Recharge

- It allows disabling or enabling any saeco card recharge operations.  
By setting RECHARGE = NO the V.M. will only deduct the cost from saeco cards

### Card prices

- This function allows applying differentiated prices in case of card use for the beverage payment.  
By setting PRICE DIFFERENTIAL = YES a new menu entry will appear in PRICE MANAGEMENT, which will allow setting the price level to be applied to the product (beverage or snack) in case of saeco card use.



### Card maximum recharge

- This function allows setting the credit maximum level, beyond which all recharge operation (if enabled) is ineffective.  
By setting MAX CARD LOAD = 20.00, the credit on the V.M. will pass to the card if their sum does not exceed 20.00.

### Reject card

- This function allows setting the credit maximum level, beyond which the card is rejected by the system.  
By setting MAX VALUE ACCEPTED = 25.00, the V.M. will reject all cards having a credit exceeding this amount. In case this card is detected, the display will not read the credit but an "-----" message and will not carry out any dispensing.

### Free Card

- It allows enabling or disabling the use of free service cards.  
By setting FREE CARD = NO, no free service card will be accepted by the vending machine.

## 10 - HANDLING KIT



This kit allows easy handling of the vending machine in order to carry out any maintenance operations and to place it in narrow spaces.



### Warning

*During handling operations be extremely careful in order to avoid any limb crushing. The handling operations can exclusively be carried out by skilled personnel.*

### Assembly kit (fig. 70)

- a. 2 carriage sets
- b. 1 lever

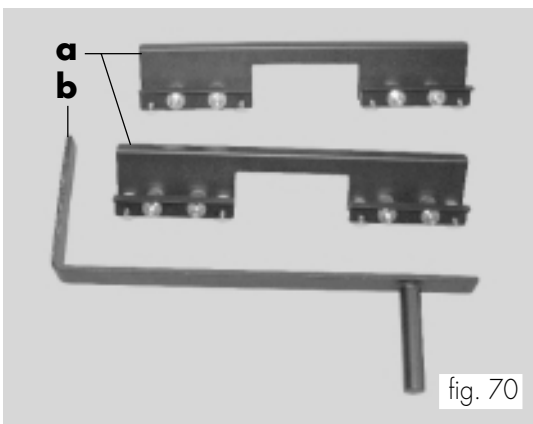


fig. 70

### Installation

- Insert the lever under the vending machine. Rotate the lever to lift the machine (fig. 71 and 72). The lever position shall allow the carriage set to be subsequently inserted.

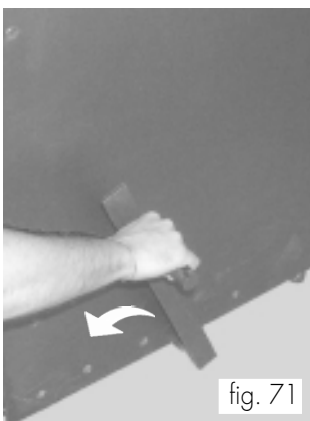


fig. 71



fig. 72

- Insert the carriage set under the V.M. (fig. 73), move the lever back to its initial position, then remove it from under the machine (fig. 74).



fig. 73



fig. 74

- Repeat the same operations for the other side of the vending machine (fig. 75, 76, 77, 78). By inserting the second carriage, it is possible to handle the machine.

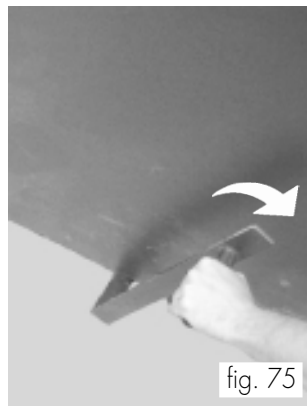


fig. 75



fig. 76



fig. 77

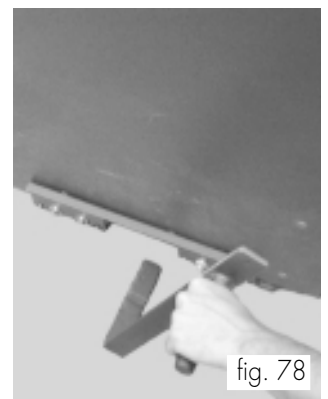


fig. 78

## 11 - BRITA PURIFIER KIT



It is possible to install a filter, manufactured by Brita Company, on the vending machine, in order to decalcify water and eliminate all unpleasant smells.

### Assembly kit (fig. 79)

- a. 2 fittings
- b. 1 cover for filter cartridge support
- c. 1 filter cartridge support
- d. 4 screws for filter cartridge support cover
- e. 4 screws for cartridge head
- f. cartridge head (not supplied)
- g. Brita Aquaquell cartridge (not supplied)
- h. 1 air break pipe
- i. 2 pipe clamps
- l. 2 pipe retaining springs
- m. 1 pump pipe

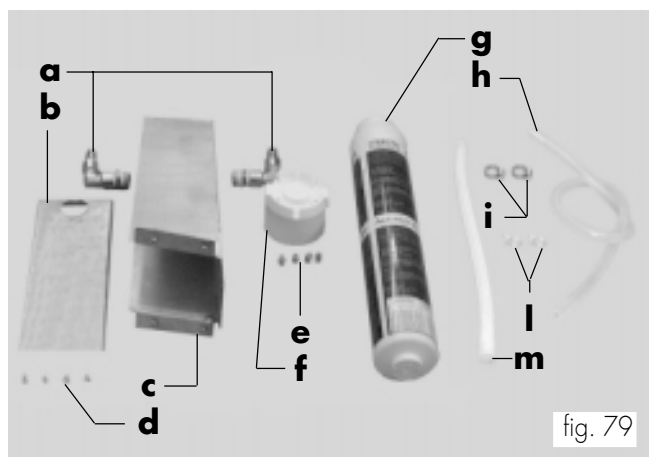


fig. 79

### Installation

- Insert the head (ref. f, fig. 79) into the support (ref. c, fig. 79) carefully following the required sense (fig. 80). Fasten the head to the support by means of the 4 screws (ref. e, fig. 79).

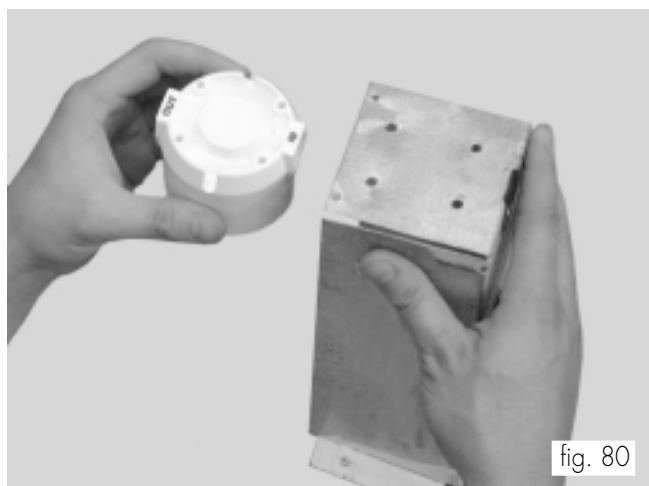


fig. 80

- Assemble the cover (ref. b, fig. 79) on the support (ref. c, fig. 79) and tighten it by using the 4 screws (ref. d, fig. 79). Then screw the 2 fittings (ref. a, fig. 79) inside the holes following the right orientation, as shown in fig. 81.

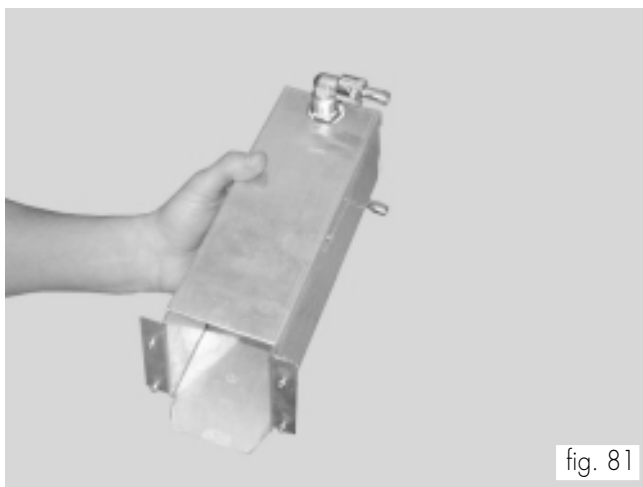


fig. 81

- Remove the machine rear panel and open the upper front door.
- Remove the hole-closing panel.
- Assemble the cartridge support set (fig. 81) and fasten it by means of the 4 screws (fig. 82 e 83)

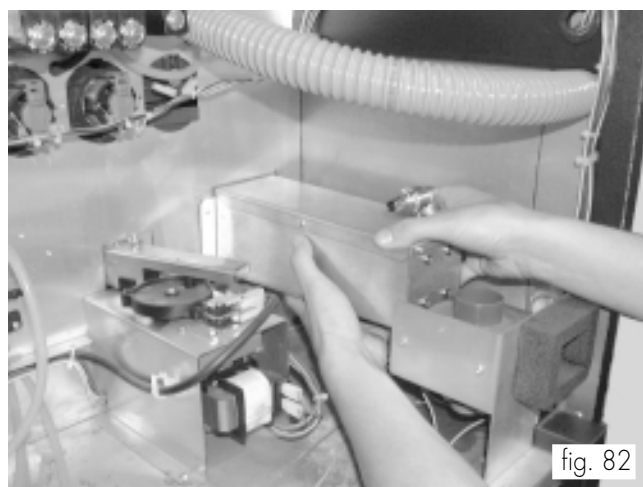


fig. 82

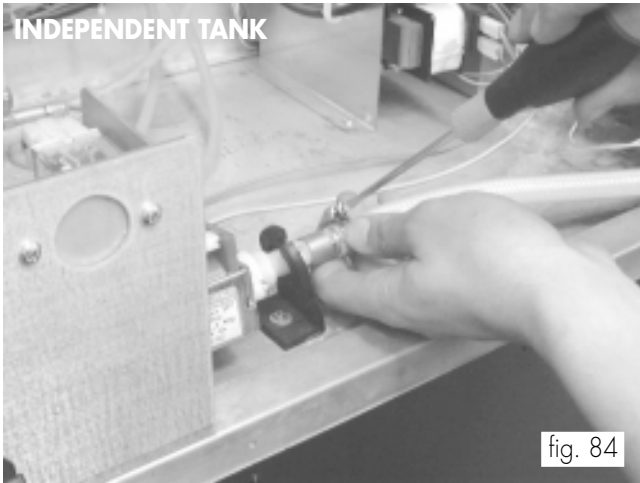


fig. 83

The following operation differs according to whether the machine is connected to a water network or if it uses an independent tank

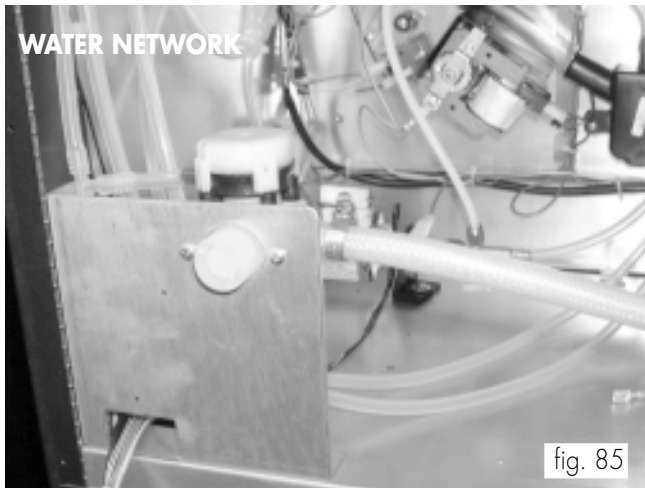
**- Independent tank**

Insert the clamp (ref. i, fig. 79) into the pipe (ref. m, fig. 79) and the latter into the pump fitting. Tighten the clamp screw (fig. 84).

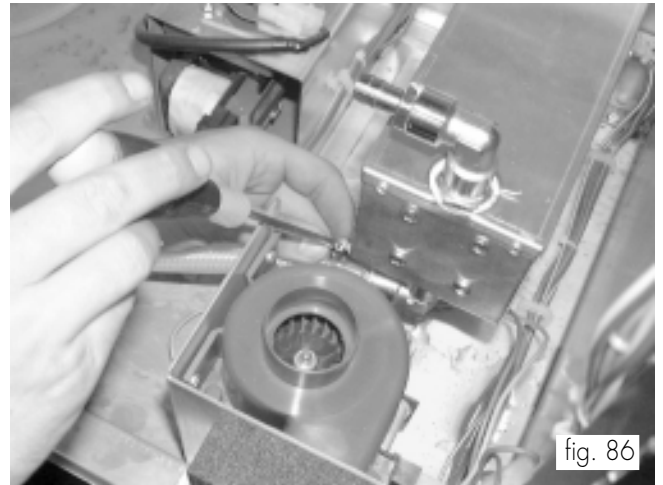


**- Water network**

Insert the clamp (ref. i, fig. 79) into the pipe (ref. m, fig. 79) and the latter into the water inlet solenoid valve fitting. Tighten the clamp screw (fig. 85).



- Insert the other clamp (ref. i, fig. 79) into the pipe free end (ref. m, fig. 79) and the latter into the lower fitting of the cartridge support set (ref. a, fig. 79). Tighten the clamp screw (fig. 86).



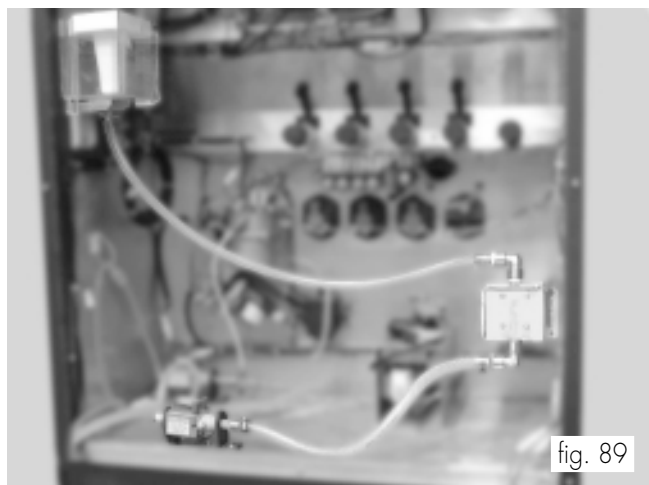
- Insert the spring (ref. i, fig. 79) into the pipe (ref. m, fig. 79) and the latter into the air break fitting (fig. 87).



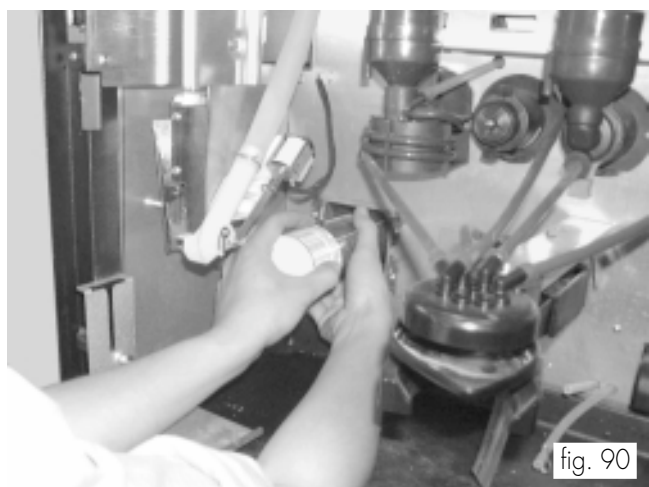
- Insert the other spring (ref. l, fig. 79) into the pipe free end (ref. h, fig. 79) and the latter (fig. 88) into the upper fitting of the cartridge support set (ref. a, fig. 79).



- The pipe connection logic is clearer in fig. 89, since some plates have been removed.



- Insert the cartridge and tighten it (ref. g, fig. 79) clockwise (fig. 90).



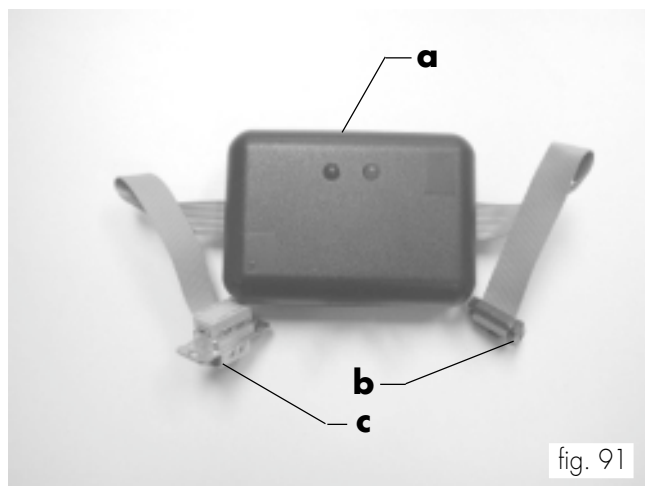
- Reassemble the rear panel and close the upper front door.

## 12 - RS 232 INTERFACE BOX

The RS232 interface box allows connecting the automatic vending machine to a PC, in order to transfer statistic data.

### Assembly kit (fig. 91)

- a. 1 TTL-RS232 level adapter



### Installation

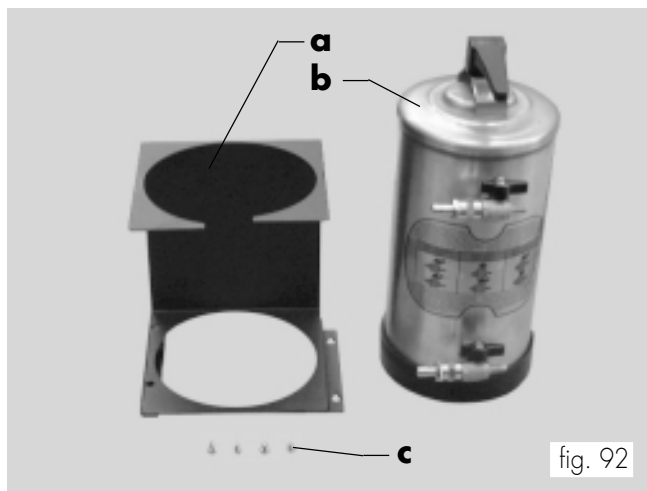
- Insert the flat cable (ref. b., fig. 91) on the machine CPU relevant connector to carry out the connection. Then insert the other flat cable (ref. c, fig. 91) into the PC serial cable.
- The interface box is supplied with 2 LEDs. When they alternatively blink, this means that the V.M. and the P.C. are communicating.
- It is advisable to carry out all the electrical connections while the V.M. and the PC are both switched off.

## 13 - SAECO WATER SOFTENER SUPPORT

This support allows fixing the water softener supplied by Saeco in a proper way.

### Assembly kit (fig. 92)

- a. 1 water softener support
- b. 1 water softener
- c. 4 screws

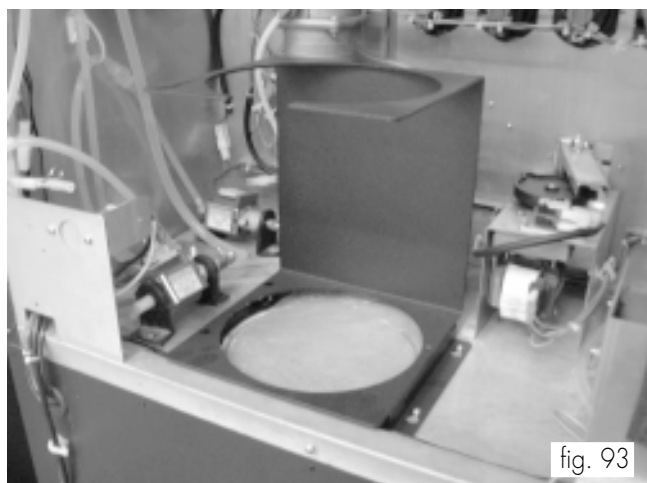


- Insert the water softener (ref. b, fig. 92) into the support (fig. 94).



### Installation

- Remove the machine rear panel and assemble the water softener support (ref. a, fig. 92) by using the 4 screws (fig. 93).





## 14 - PROGRAMMING KEY



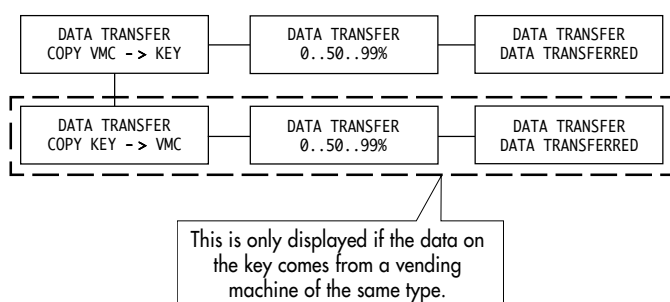
The programming key allows the set data transfer in the following programming menu entries:

- **PRICE MANAGEMENT.** All data can be transferred;
- **TIME MANAGEMENT.** All data can be transferred;
- **PAYMENT SYSTEMS.** All data can be transferred;
- **SYSTEM MANAGEMENT.** All data can be transferred, expect the PASSWORD.

To properly use the programming key, do as follows:

- open the vending machine front door;
- insert the programming key into the connector (ref. 6, fig. 1).
- switch on the vending machine.

The copy key presence enables the following menu display:



The allowable operations are the following:

Display message	Operation	Notes
DATA TRANSFER COPY VMC ==> KEY	copy of vending machine data on the key	This operation is always possible.
DATA TRANSFER COPY KEY ==> VMC	copy of key data on the vending machine	This operation is only possible if the data on the key comes from a vending machine of the same type.

Any possible data transfer error is shown on the display through the "TRANSFER KEY - ERROR IN KEY DATA" message. Should this message appear, repeat the transfer procedure, and if the error is not removed, please contact the AUTHORIZED CUSTOMER SERVICE CENTER.

## 15 - 12V PARALLEL COINER KIT

Allows to use 12Vdc parallel coin selectors.

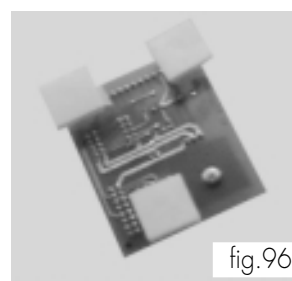
### Assembly kit (fig. 95)

- a.** 16-pole flat cable
- b.** 3 adhesive spacers
- c.** 10-pole flat cable
- d.** Interface card

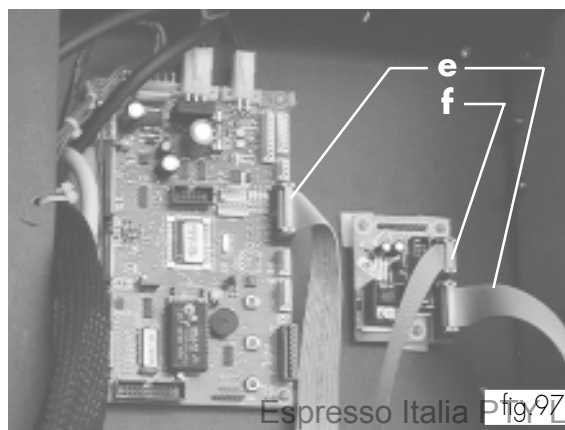


### Installation

- Open the upper door and slide the keypad carter up. Insert the 3 adhesive spacers (fig. 95, **b**) into the special holes of the interface card (fig. 95, **d**) and remove their protective paper (fig. 96). Fasten the card in the most convenient position for the user.



- Insert the 16-pole flat cable (fig. 95, **a**) into the special seats of the CPU card and interface card (see fig. 97, **e**).
- Insert the 10-pole flat cable (fig. 95, **c**) into the interface card seat (see fig. 97, **f**), then connect the other end of the 10-pole flat cable to the 12V parallel selector.



# 16 - CLOCK MODULE INSERTION (TIME KEEPER)



To insert the clock module, do as follows:

- open the vending machine front door;
- insert the clock module into the CPU card connector (7 - Fig. 1).



### Warning

Insert the clock module **A** from the lower part of connector **B**.

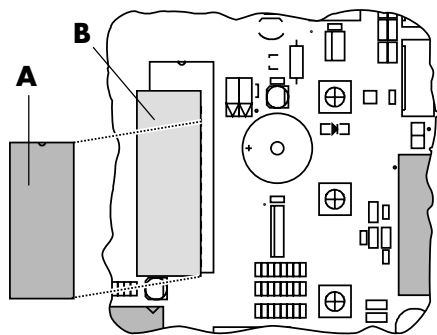


fig. 98



### Important

The functions managed by the TIME KEEPER are described later on at 16.1 and 16.2 manual sections.

## 16.1 - TIME KEEPER functions in the programming menus

### Price management

This menu allows setting 2 different differentiated prices (DIFFERENTIATED PRICES 1, DIFFERENTIATED PRICES 2), which are only enabled at a certain time.

### Timetable management

Besides the ALWAYS FREE and NEVER FREE functions, this menu allows setting the time for FREE beverages/selections (i.e. FREE - Monday - ON=20,00 - OFF=24,00. The beverages/selections will be free each Monday from 8 to 12 pm).

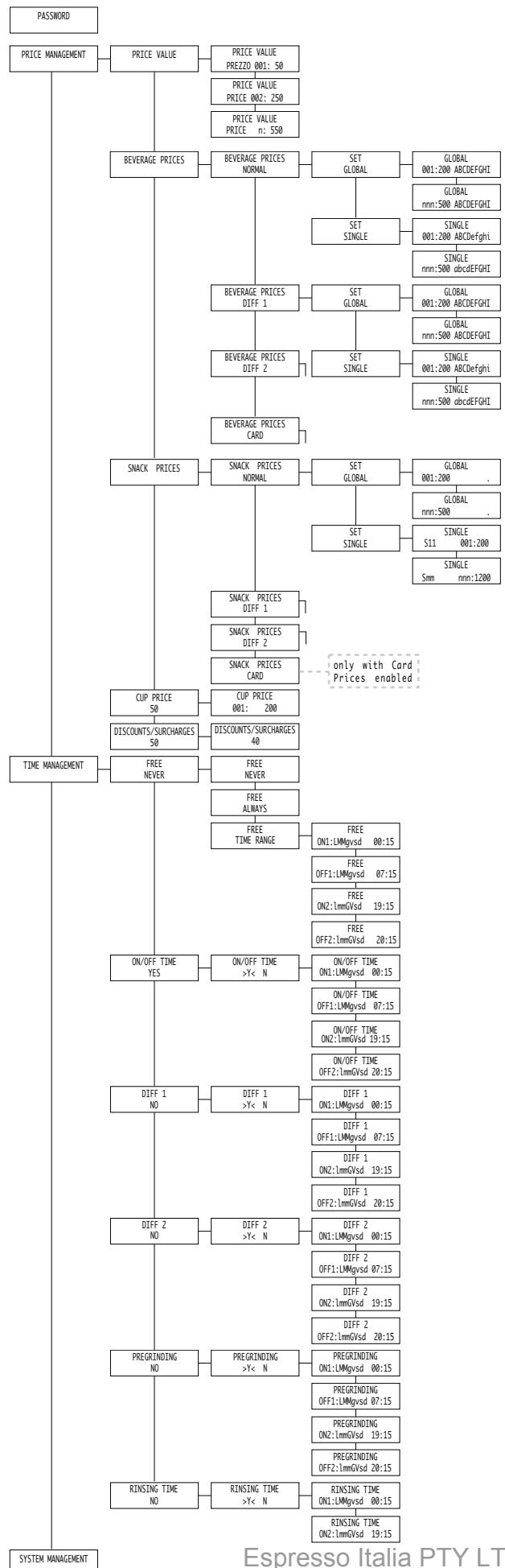
The DIFFERENTIATED PRICES 1 and 2 associated to any beverage or selection can be equally set.

It is also possible to set:

- the time for the machine switching on and off;
- the time for the pregrinding enabling;
- the rinsing time.

### System management

This menu allows accessing the CLOCK function in order to set hour, minutes, month and year.



## 16.2 - TIME KEEPER functions in the maintenance menus

### STATISTIC

With this function you can display all sales statistics accounted by the vending machine.

### VM CODE

assigned by the operator.

### COINS TOTAL

the total value of the inserted coins is displayed.

### BANKNOTE TOTAL

the total value of the inserted banknotes is displayed. By pressing [ENTER] it is possible to display the number of inserted banknotes according to their denomination.

### CARD IN

the amount of credit collected from cards is displayed

### CARD OUT

the amount of credit charged on cards is displayed

### OVERPAY:

the amount of credit kept at the OVERPAY time elapsing.

### FREE BEVERAGES

the total number of free selections dispensed is displayed.

### BEVERAGE TEST

the total number of test beverages brewed is displayed.

### FREE SELECTIONS

the total number of free selections dispensed is displayed.

### TOTAL SALES:

the total gain from the sales of all selection and beverage is displayed

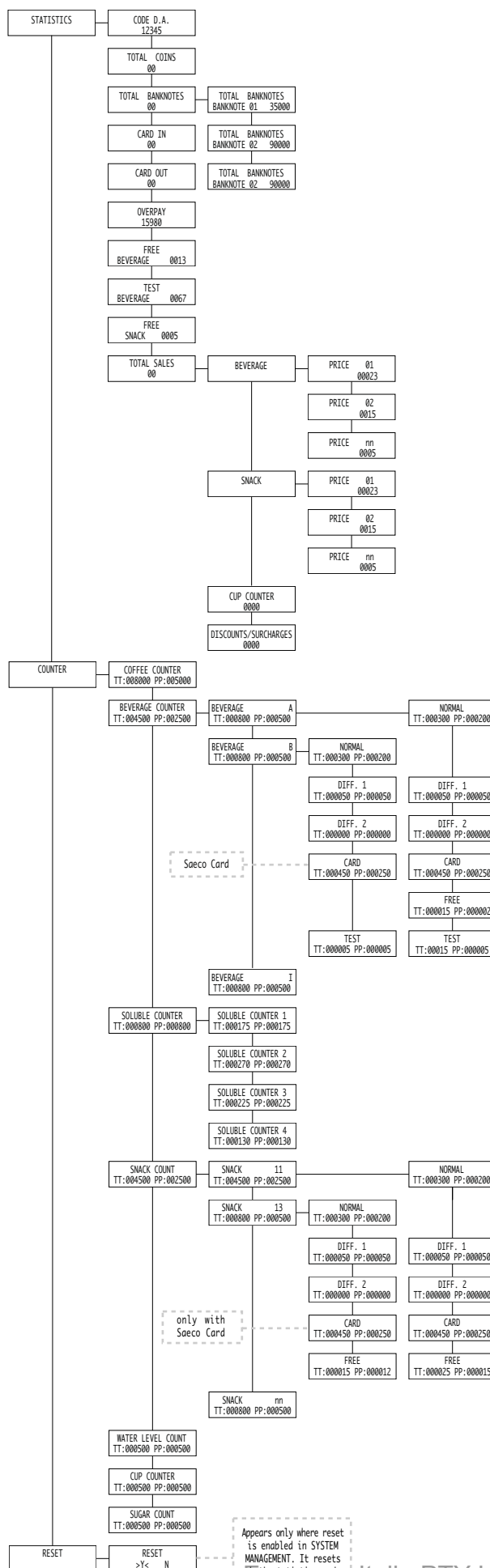
By pressing [ENTER] it is possible to get detailed information of this gain for:

- beverages (further divided according to price level, if required),
- snack selections (also divided according to price level)
- cups sold
- discounts granted

### COUNTERS

The presence of the Time keeper in this menu allows the displayed information extension.

Therefore, it is possible to display the total and partial number of beverages and snack selections divided by price brackets.



Cod. 0875.978 - Ed° 01 02/03

Espresso Italia PTY LTD  
[www.espressoitalia.com.au](http://www.espressoitalia.com.au)  
Freecall 1300 660 976