

D.A. ATLANTE



Type: D.A. SG 650



USE AND MAINTENANCE

MAIN PARTS ATLANTE

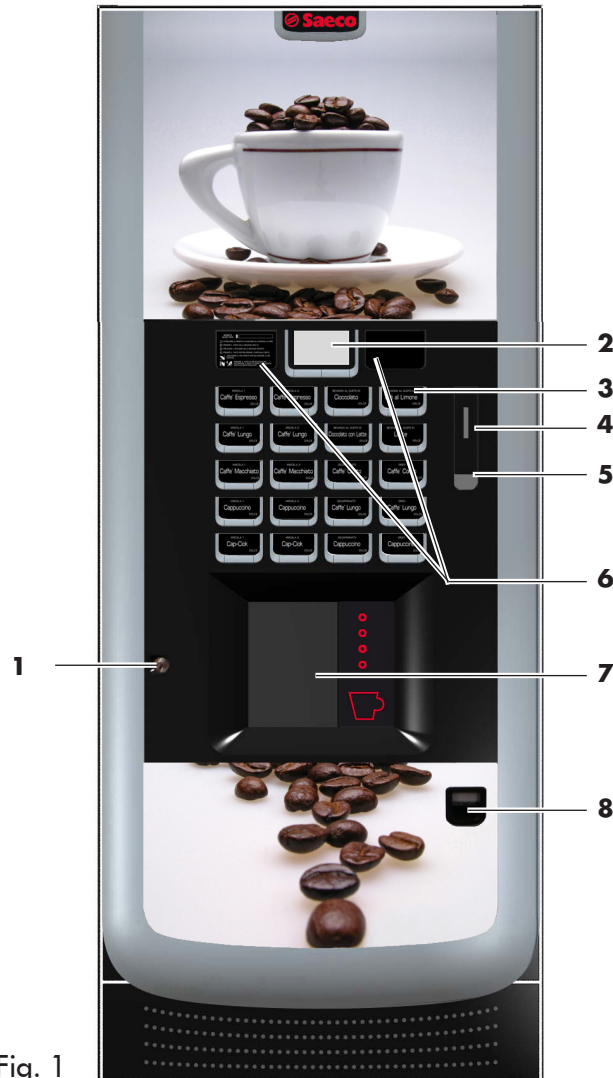

Fig. 1

1	Door lock
2	Display
3	Product keypad
4	Coin slot
5	Change return key
6	Instruction plate
7	Dispensing outlet door (beverage/cup dispensing)
8	Change removal outlet

MAIN PARTS ATLANTE

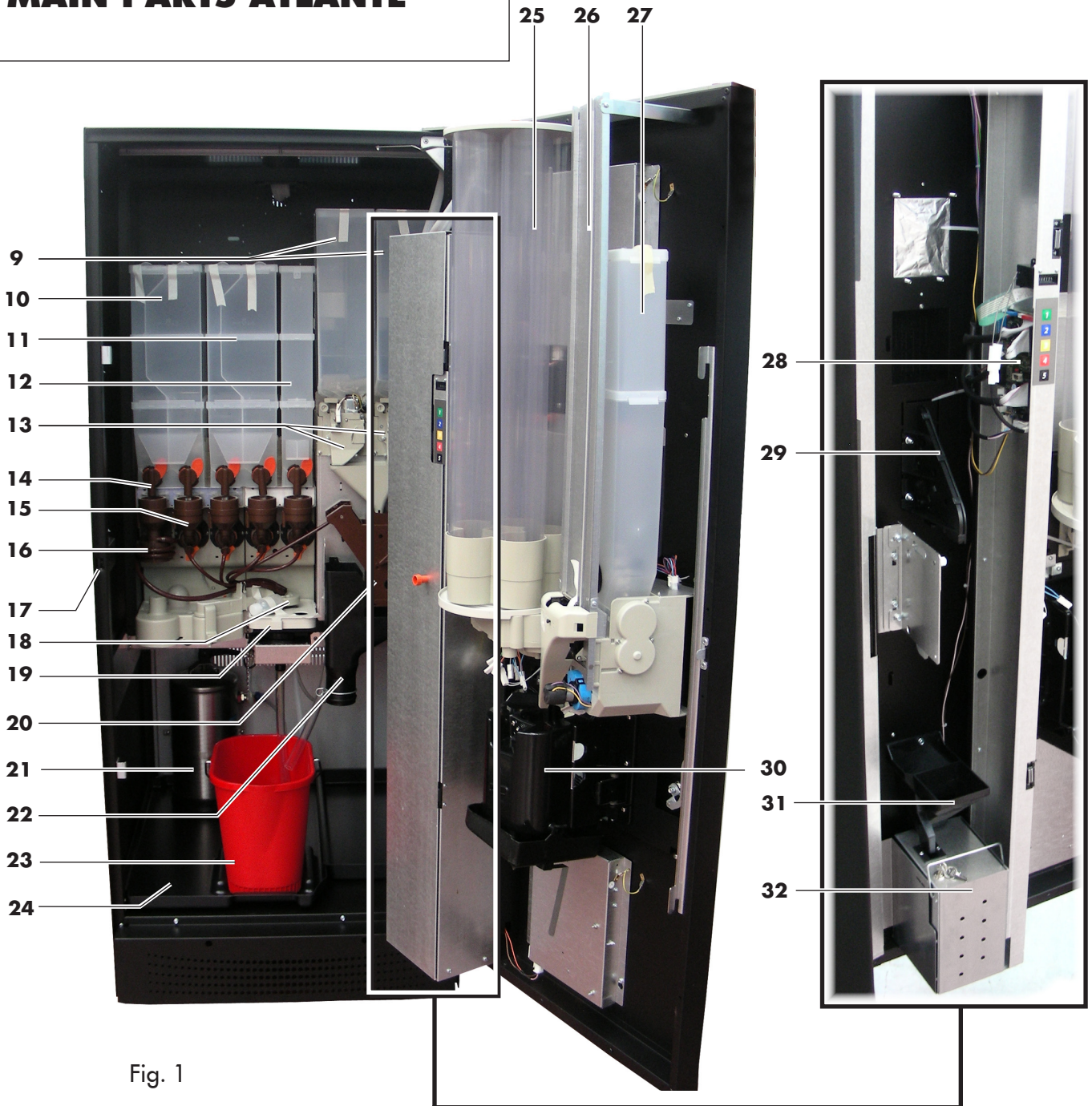

Fig. 1

9	Coffee bean hopper
10	Container 1/2 (instant products)
11	Container 3/4 (instant products)
12	Container 5 (instant products)
13	Coffee grinder
14	Instants opening
15	Mixer
16	Spiral mixer
17	Safety switch
18	Dispensing arm
19	Drip Tray
20	Brew group
21	Descaler device

22	Coffee ground channel
23	Fluid discharge tank
24	Collecting tray
25	Cup dispenser
26	Stirrer dispenser
27	Sugar container
28	CPU card
29	Change-giving coiner support
30	Dispensing outlet
31	Coin return duct
32	Coin box set

MAIN PARTS ATLANTE

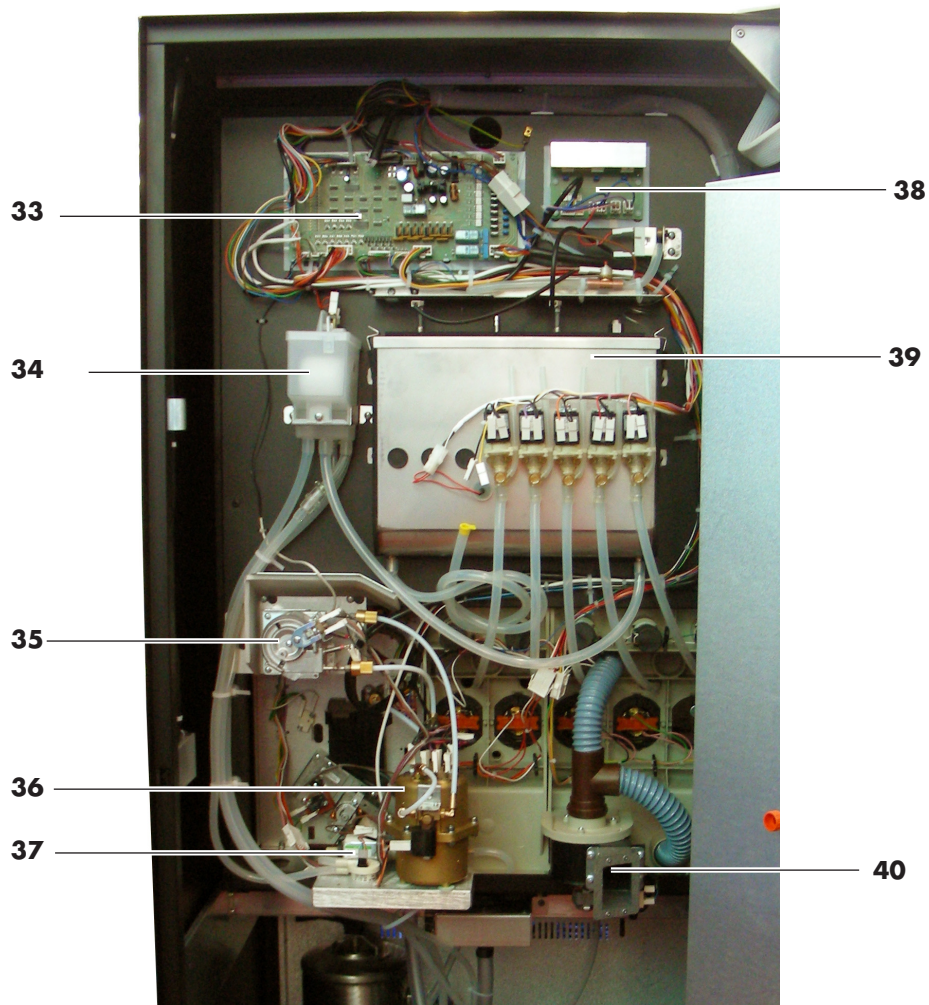
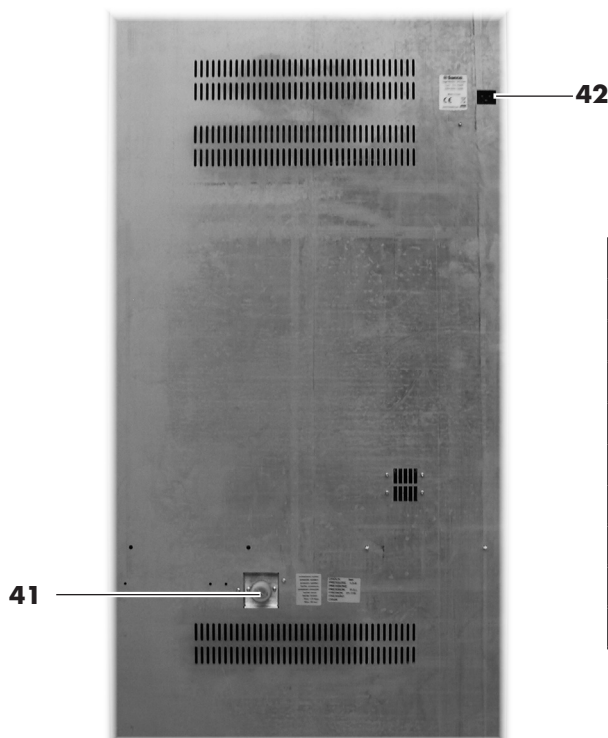

Fig. 1



33	Power Board
34	Air break device
35	Steam boiler
36	Coffee boiler
37	Pump
38	Triac board
39	Instant product boiler
40	Suction unit
41	Water connection coupling
42	Power cord socket

CONTENTS

MAIN PARTS ATLANTE	2	8 PROGRAMMING AND MAINTENANCE MENU	28
MAIN PARTS ATLANTE	3	8.1 Key description of programming and maintenance phases.....	28
MAIN PARTS ATLANTE	4	8.2 Programming menu	28
CONTENTS	5	8.2.1 Entering the programming menu	28
1 INTRODUCTION TO THE MANUAL	6	8.2.2 Structure of the programming menu	29
1.1 Introduction.....	6	8.2.3 Description of messages in the programming menu	30
1.2 Symbols used.....	6	8.3 Maintenance menu	43
2 INFORMATION ON THE VENDING MACHINE	6	8.3.1 Entering the maintenance menu	43
2.1 Information for the Maintenance Technician	6	8.3.2 Structure of the maintenance menu	43
2.2 Description and intended use	7	8.3.3 Description of messages in the maintenance menu	44
2.3 Vending Machine Identification	7	8.4 Machine Ready/Free Button	46
2.4 Technical specifications Atlante	8	8.5 Reset	46
3 SAFETY.....	9	9 OPERATION AND USE.....	46
3.1 Introduction.....	9	9.1 Beverage selection.....	46
3.2 General safety regulations	9	10 CLEANING AND MAINTENANCE.....	47
3.3 Operators' requirements.....	9	10.1 General notes for correct operation	47
3.4 Safety devices.....	10	10.2 Cleaning and scheduled maintenance	47
3.5 Residual risks	10	10.2.1 Maintenance schedule.....	47
4 HANDLING AND STORAGE	11	10.2.2 Drip tray cleaning	48
4.1 Unloading and handling	11	10.2.3 Replacement of the coffee ground bag	48
4.2 Storage	11	10.2.4 Emptying the fluid discharge tank.....	48
5 INSTALLATION.....	12	10.2.5 Cleaning of the coffee brew group	49
5.1 Important.....	12	10.2.6 Cleaning the instant product dispenser and the mixer.....	49
5.2 Unpacking and positioning.....	12	10.2.7 Cleaning the dispensing outlet.....	51
5.3 Use of different-sized stirrers	14	10.2.8 Cleaning the containers	51
5.4 Label application	15	10.2.9 Cleaning the dispensing arm	53
5.5 Fitting the coffee grounds bag	19	10.2.10 Cleaning the coffee grinder	53
5.6 Fitting the payment systems	19	10.2.11 Cleaning the sugar dispensing channel.....	53
5.7 Connection to water mains	20	10.2.12 Cleaning the stirrer channel	54
5.8 Connection to the electric network.....	20	10.3 Non-scheduled maintenance.....	55
6 CONTROLS DESCRIPTION.....	21	10.4 Software update.....	56
6.1 Display.....	21	11 DISPLAY MESSAGES.....	57
6.2 Keypad	21	11.1 Messages during operation	57
6.3 Key description in standard operation mode	21	11.2 Error messages.....	57
6.4 CPU card keys	21	12 STORAGE - DISPOSAL.....	59
7 SUPPLY AND STARTING UP	22	12.1 Change of location	59
7.1 Container supply (Instant).....	22	12.2 Inactivity and storage periods.....	59
7.2 Container supply (Single Grinder)	22	13 INSTRUCTIONS FOR END-OF-LIFE DISPOSAL TREATMENT.....	59
7.3 Container supply (Double Grinder)	22		
7.3.1 Instant product supply	23		
7.3.2 Sugar supply	23		
7.3.3 Coffee bean supply	23		
7.4 Dose calibration	24		
7.5 Coffee grinding calibration.....	24		
7.6 Setting the water capacity for instant product solenoid valves.....	24		
7.7 Stirrer supply.....	25		
7.8 Cup supply.....	25		
7.9 First start-up of the vending machine	26		
7.10 Water circuit filling.....	26		
7.10.1 Automatic filling of the instant product boiler	26		
7.10.2 Filling the coffee boiler manually.....	27		
7.11 Cleaning the parts in contact with foodstuffs.....	27		
7.12 Use of the vending machine.....	27		

1 INTRODUCTION TO THE MANUAL

1.1 Introduction

Important

This publication is an integral part of the vending machine and must be read carefully to ensure the machine is used correctly and in compliance with essential safety requirements.

This manual contains the technical information required for the correct use, installation, cleaning, and maintenance of the vending machine model **ATLANTE**. Always refer to this publication before carrying out any operation.

Manufacturer: **SAECO Vending S.p.A.**

Località Casona, 1066 - 40041 Gaggio Montano
Bologna, Italy

This publication should be kept carefully, together with the vending machine throughout its operational life, even in case of changes of ownership.

Should this manual be lost or worn out, a copy can be requested from the Manufacturer or an Authorized Customer Service Centre by indicating all data on the identification plate on the back of the vending machine.

1.2 Symbols used

This publication contains various warnings which indicate different degrees of danger or skills required.

The symbol is integrated with a message suggesting use procedures or actions and providing useful information for the correct operation of the machine.

Warning

Indicates dangerous situations for the users, supply operators and maintenance technicians dealing either with the vending machine or the product to be dispensed.

Important

Indicates the operations for keeping the vending machine in good working order.

Recommended solutions

Indicates alternative procedures that make the programming and/or maintenance operations quicker.



User

Indicates the user of the vending machine. This person is not authorized to carry out any cleaning or maintenance operation.



Supply operator

Indicates operations to be carried out only by personnel in charge of supplying and cleaning the vending machine. Maintenance operations requiring a Maintenance Technician are not to be performed by the supply operator.



Maintenance Technician

Indicates operations to be carried out by qualified personnel in charge of maintenance. The Maintenance Technician is the only person authorized to keep the **MICROSWITCH ENABLING KEY**, by which the security systems can be disabled.

2 INFORMATION ON THE VENDING MACHINE

2.1 Information for the Maintenance Technician

The vending machine must be installed in a well-lit, dry area, away from bad weather and dust, on a floor suitable to support its weight.

To guarantee the correct operation and reliability over time, the following is recommended:

- ambient temperature: from +1°C to +32°C;
- maximum humidity: 90% (not condensed).

For special installations not covered in this publication, please contact the dealer or the local importer. If this is not possible, please contact the Manufacturer directly.

AUTHORIZED CUSTOMER SERVICE CENTRES are available for information and explanations about the vending machine, and to provide technical assistance or spare parts.

The Maintenance Technician must carefully read and respect the safety warnings contained in this manual so that every intervention concerning installation, starting up, use and maintenance will be safely carried out.

It is the Maintenance Technician's absolute responsibility to give the keys to access the inside of the vending machine to another operator (Supply Operator), provided that the Maintenance Technician bears full responsibility for all work carried out.

This manual is an integral part of the machine and must be always read carefully before performing any operation.

2.2 Description and intended use

The vending machine is intended for automatic distribution of coffee and hot beverages (decaffeinated coffee, cappuccino, chocolate, etc.) and is programmable for every single type of dispensing dosage. The instant products must be consumed immediately, and cannot be preserved for a long time.

Any other use is to be considered improper and therefore dangerous.

Do not place any product inside the distributor which may be dangerous as a result of unsuitable temperatures.



Important

Improper use of the vending machine invalidates all warranties. The Manufacturer declines any liability for damage to property or injury to persons. Improper use also includes:

- any use of the vending machine other than the intended use and/or according to procedures which are not described in this publication;
- any intervention on the vending machine which differs from the instructions given in this publication;
- any alteration of components and/or safety devices without prior consent of the Manufacturer or carried out by personnel not authorized for such operations;
- any location of the appliance which is not recommended in this manual.

2.3 Vending Machine Identification

The vending machine is identified by the name, model and serial number which can be found on the relevant data plate (Fig. 2).



Fig. 2

The following data can be found on the plate:

- name of Manufacturer;
- marks of compliance;
- model;
- serial number;
- year and month of manufacture;
- supply voltage (V);
- supply frequency (Hz);
- electrical power consumption (W).



Warning

It is strictly forbidden to tamper with or modify the data plate.



Important

When contacting the AUTHORIZED CUSTOMER SERVICE CENTRES always refer to this plate and its relevant data.

2.4 Technical specifications Atlante

Weight: 184 kg

Overall dimensions:.....see figure 3



Fig. 3

Power consumption: see data plate

Supply voltage: see data plate

Electric voltage frequency:..... see data plate

Power cord length:2500 mm

Water mains connection: 3/4" Gas type

Min. water inlet pressure:.....0.15 MPA (1.5 bar)

Max. water inlet pressure:.....0.8 MPA (8 bar)

(see figure 4)

A-Weighted sound pressure level:less than 70 dB

Data plate showing minimum and maximum water supply pressure



Fig. 4

Container capacity

Coffee beans (1 Grinder model): 4,2 kg

Coffee beans (2 Grinders model):..... 3,5 + 3,5 kg

Freeze-dried coffee (Instant Model):..... 1.2 kg

Decaffeinated coffee:..... 1 kg

Chocolate: 3 kg

Milk: 2,5 kg

Lemon tea:..... 3 kg

Barley 1 kg

Sugar:

Espresso version, 1 and 2 grinders 4.5 kg

Instant version 4 kg

Cups: No. 700

Stirrers: No. 550

Stirrer size

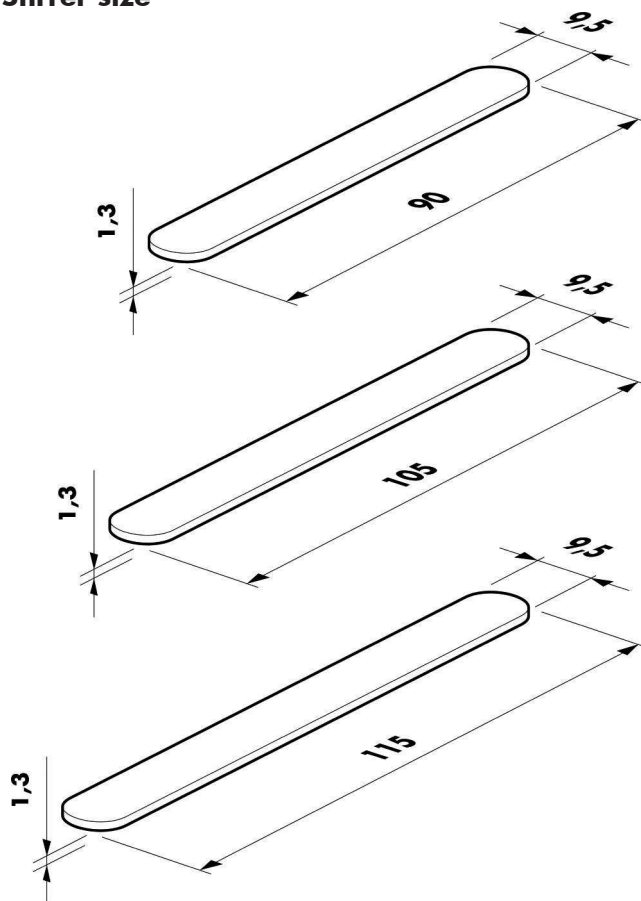

Fig. 5

3 SAFETY

3.1 Introduction

In compliance with the Low Tension Directive 2006/95/EC (which replaces the directive 73/23/EEC and following amendments) and CE Marking Directive 93/68/EEC, **SAECO VENDING** has drawn up a technical file of the **ATLANTE** vending machine held at its plants. The following regulations were taken into account during the design phase:

- EN 55014
- EN 61000-3-2
- EN 61000-3-3
- EN 61000-4-2
- EN 61000-4-3
- EN 61000-4-4
- EN 61000-4-5
- EN 61000-4-11
- EN 60335-2-75
- EN 60335-1

3.2 General safety regulations

It is forbidden to:

- tamper with or disable the safety systems installed on the vending machine;
- carry out maintenance on the vending machine without unplugging it first;
- install the vending machine outdoors. It should be placed in dry areas where the temperature never falls below 1°C;
- use the vending machine for purposes other than those indicated in the sale contract and in this publication;
- connect the appliance to the mains using multi-sockets or adapters;
- Use a new gasket kit every time you disconnect and then connect again the machine to the water supply.
- use water jets to clean the vending machine (Fig. 6).



Fig. 6

It is compulsory to:

- check the electrical power line for conformity;
- use original spare parts;
- read the instructions contained in this publication and in the enclosed documents carefully;
- use personal protection devices during installation, testing and maintenance operations.

Precautions for preventing human errors:

- make the operators aware of safety issues;
- handle the vending machine, either packaged or unpackaged, in safe conditions;
- have a thorough knowledge of the installation procedures, its operation and limits;
- dismantle the vending machine in safe conditions, in accordance with the environmental protection and health and safety laws in force.



Warning

In case of failure or malfunctioning contact only qualified CUSTOMER SERVICE personnel.



Important

The Manufacturer declines any liability for any damage caused to property or injury caused to persons as a result of failure to observe the safety regulations described here.

3.3 Operators' requirements

Three operators with different skills are required in order to guarantee the safety of the vending machine:



User

Access to the internal part of the vending machine is forbidden to the user.



Supply operator

The Maintenance Technician assigns the safekeeping of the access key to the Supply operator who is in charge of product supply, external cleaning, and starting up / stopping of the vending machine.



Warning

The Supply Operator is not authorized to carry out operations which are indicated as being the duties of the Maintenance Technician in this publication.



Maintenance Technician

The Maintenance Technician is the only person authorized to intervene and start programming procedures, and perform adjusting, setting up and maintenance operations on the vending machine.

3.4 Safety devices

The vending machine is equipped with:

- a safety switch (Ref.17) which cuts out the voltage to all the inside components any time the front door is opened.
- a safety switch located on the dispensing outlet door, which blocks the nozzle arm cycle whenever the door is opened.



Maintenance Technician

In case of programming or setting up operations only the Maintenance Technician can intervene by inserting the relevant key into the safety switch (Fig. 7) and resetting the voltage even if the door is open.

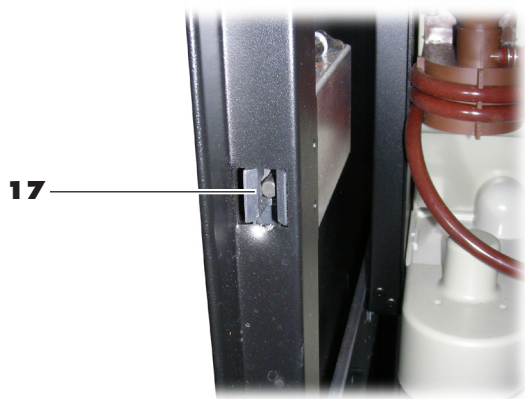

Fig. 7



Warning

This operation, necessary for starting up the vending machine, disables the safety system.

It must therefore be carried out by qualified personnel (Maintenance Technician) aware of the risks resulting from the presence of live or moving components.

3.5 Residual risks

The dispensing outlet is protected by the door interlocked by the safety switch.

If it is opened during the brewing cycle, mechanical movement is blocked, but if brewing has already started, it continues up to the end of the cycle.



Warning

Risk of scalding if hands are placed inside the outlet during brewing.

It is forbidden to open the door and take out the cup or put hands inside the outlet during dispensing, before the brewing cycle is complete (Fig. 8).

Before removing the cup from the outlet, please wait for the message "REMOVE CUP" on display.



Fig. 8



Important

If the outlet door is opened during the brewing cycle, the message "CLOSE SERVICE DOOR" will be displayed; the nozzle arm stops and will not restart until the door is closed.

It is not possible to brew further beverages if the previous cup is not taken out (see the "Dispensing outlet microswitch" menu item).

Before brewing another beverage, check that the previous one has been taken out and that the cup support is empty.

4 HANDLING AND STORAGE

4.1 Unloading and handling

Unloading and handling operations after transportation must be carried out only by qualified personnel and using suitable equipment.

The vending machine is placed on a pallet, protected by a sack, by a shrink film and four angle bars (Fig. 9).

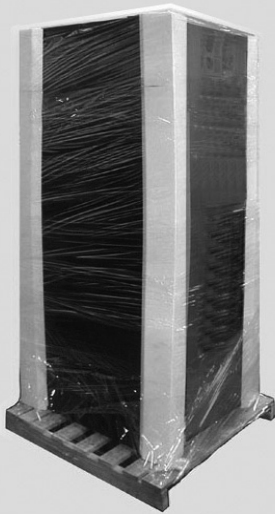

Fig. 9

Use a fork-lift to unload the vending machine from the transport vehicle (Fig. 10).

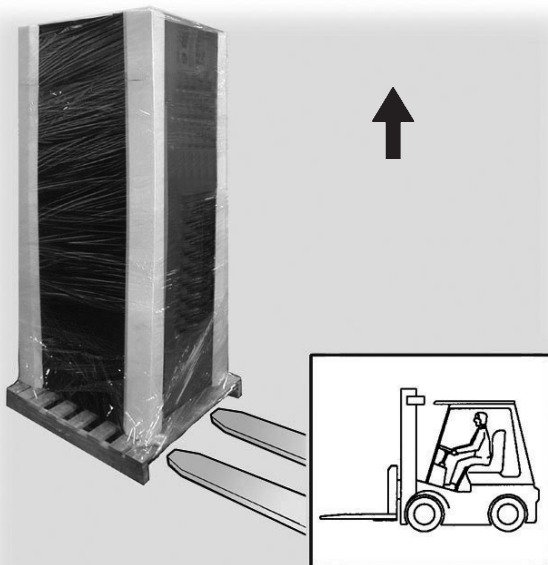

Fig. 10



Warning

The vending machine must always be kept in the upright position. Avoid:

- dragging the vending machine;
- overturning or laying the vending machine flat during transport and handling;
- shaking the vending machine;
- lifting the vending machine with ropes or cranes;
- leaving the vending machine exposed to the elements, in humid areas or close to heat sources.

4.2 Storage

If the vending machine is not installed immediately, it should be stored in a sheltered area, conforming to the following instructions:

- the packaged vending machine must be stored in a closed, dry area at a temperature between 1°C and 40°C;
- do not put other appliances or boxes on the vending machine (Fig. 11);
- it is always good practice to protect the vending machine from any deposits of dust or other material.



Fig. 11

5 INSTALLATION

5.1 Important



Warning

The vending machine cannot be installed outdoors; avoid placing it in areas where the temperature is less than 1°C or more than 32°C and in particularly damp or dusty areas.

Positioning operations require at least 2 operators.

Before unpacking, check that the installation area complies with the following specifications:

- the power socket must be located in an easily accessible area, not more than 1.5 meters away;
- the socket voltage must comply with that on the identification plate;
- the surface or floor must NOT have a gradient of more than 2°.

If the vending machine needs to be positioned close to a wall, it is necessary to leave a space of at least 15 cm between the back and the wall in order to keep the air outlet grille free (Fig. 12).



Fig. 12

5.2 Unpacking and positioning



On receipt of the vending machine make sure that it has not been damaged during transportation and that package has not been tampered with or that internal parts have not been removed.

An envelope, called "CUSTOMER KIT" is supplied with the vending machine; it contains the objects shown in Fig. 13.

- Instruction booklet
- Power cord
- Door safety microswitch disabling keys (Maintenance Technician)
- Product labels and prices
- Instruction plate
- Coin box labels

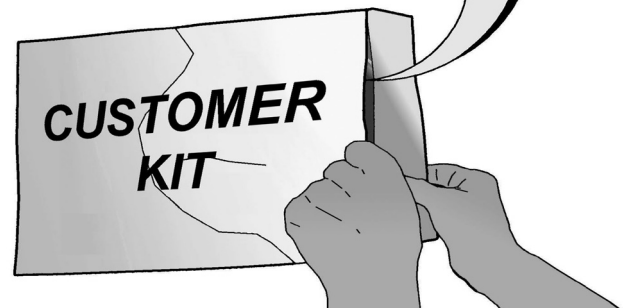

Fig. 13

Remove the transparent protective film and the four angle bars (Fig. 14).



Fig. 14

If damage of any kind is found, the courier must be informed and notice must be given to the importer or the seller immediately. If these are not in the purchaser's country, please contact the manufacturing company directly.

From the discharge tank, take out the accessory packet containing the following items:

- 4 feet;
- 1 key for the brew group;

Lift the pallet in a way that the four fixing **A** screws can be removed (Fig. 15).

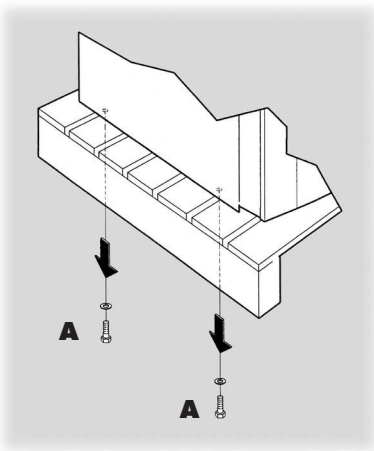
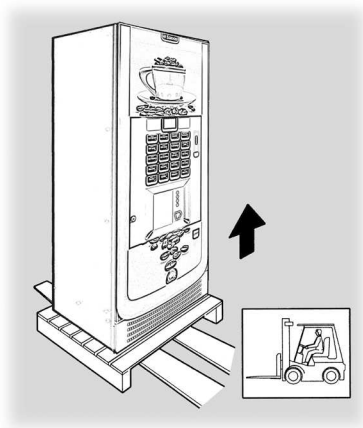

Fig. 15

To lift the pallet so that the four supporting **B** feet can be screwed on (Fig. 16), it is necessary to remove the skirting.

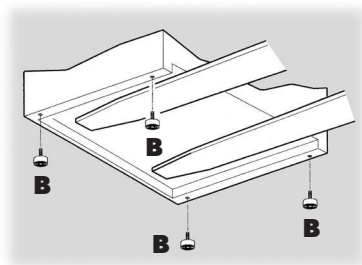
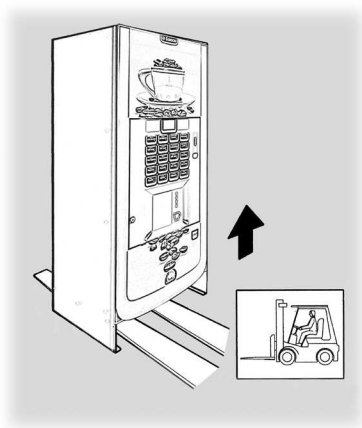

Fig. 16

In order to perform this operation, take the key from the dispensing outlet (Fig. 17).



Fig. 17

Insert the key into the lock, turn clockwise and open the door (Fig. 18).



Fig. 18

Loosen the two screws to release the kickplate (Fig. 19)

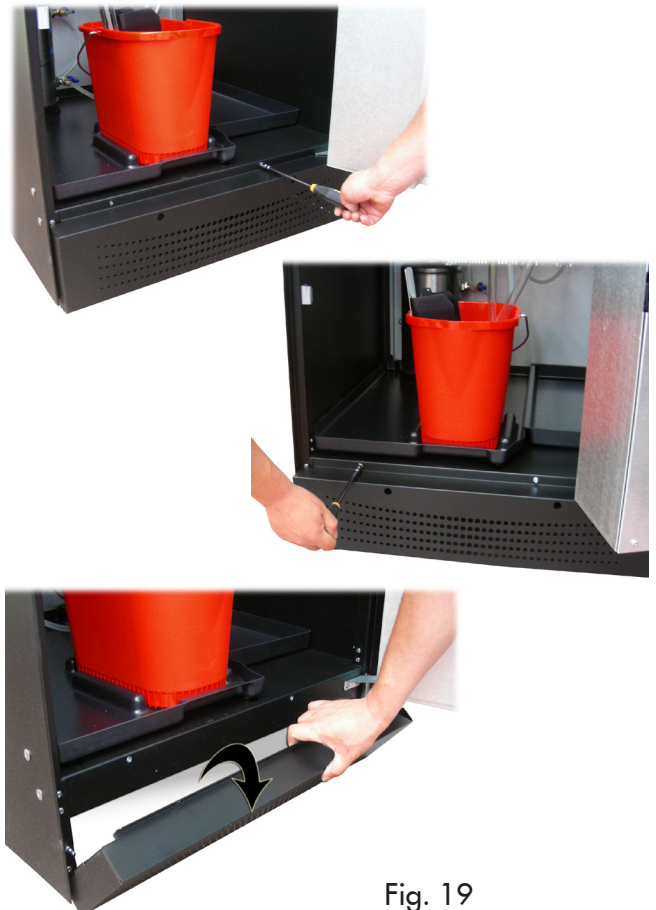

Fig. 19

Adjust the levelling using the relevant feet (Fig. 20).

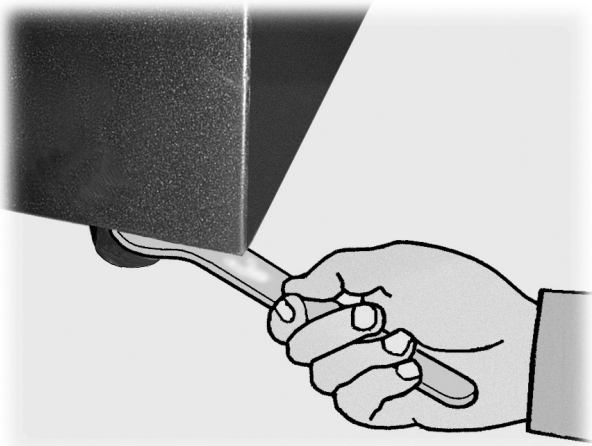

Fig. 20

Before operating the machine, unscrew the 4 screws to remove the central plate support bracket (Fig. 21).



Fig. 21

5.3 Use of different-sized stirrers



The vending machine is delivered with the stirrer set designed for use of 90 mm stirrers.



Warning

If 90 mm stirrers are used, make sure that the rubber pin (Fig. 22) is inserted in the hole (Fig. 23).

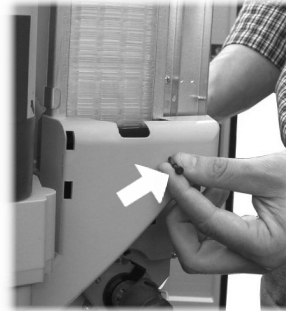

Fig. 22

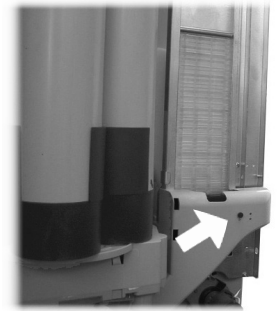

Fig. 23

To substitute the 90 mm stirrers with those of 105 mm or 115 mm proceed as follows:

- Unfasten the two screws fixing the stirrer guide (Fig. 24 and 25);

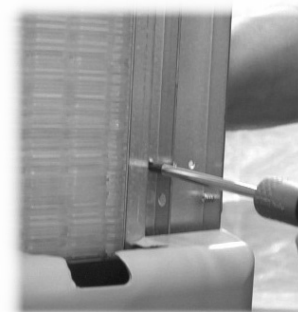

Fig. 24



Fig. 25

- Move the stirrer guide into the hole (Fig. 26) corresponding to the desired dimension and tighten the two screws.

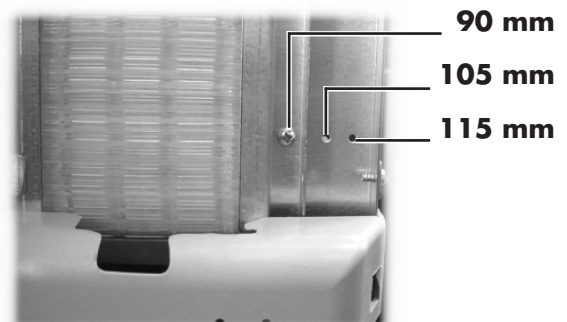

Fig. 26

5.4 Label application

Product labels

Remove the cup dispenser and unscrew the 4 knobs holding the keypad panel in place (Fig.27).

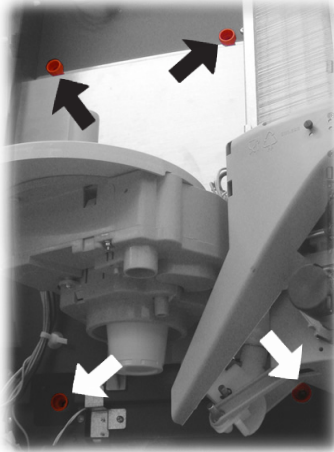

Fig. 27

Remove the protection and disconnect the connectors shown in Fig. 28.

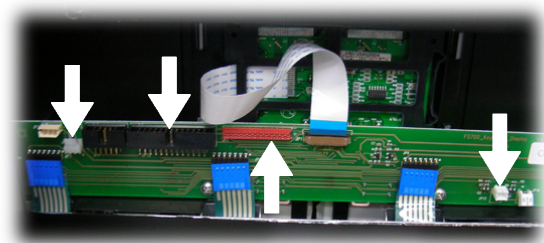
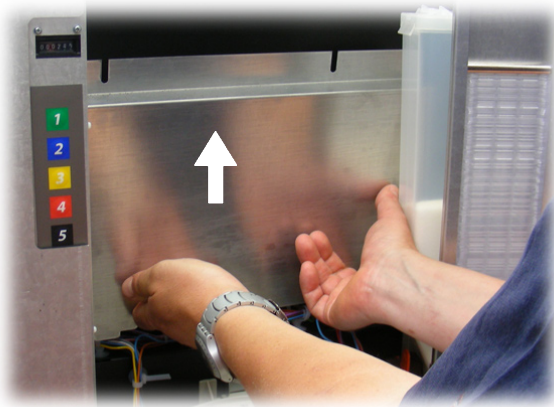

Fig. 28

Withdraw the keypad panel (Fig. 29).



Fig. 29

Insert the product labels (Fig. 30).



Fig. 30

Check the exact position of the labels against the selection key (Fig. 31,32 e 33).

Standard product configuration

INSTANT

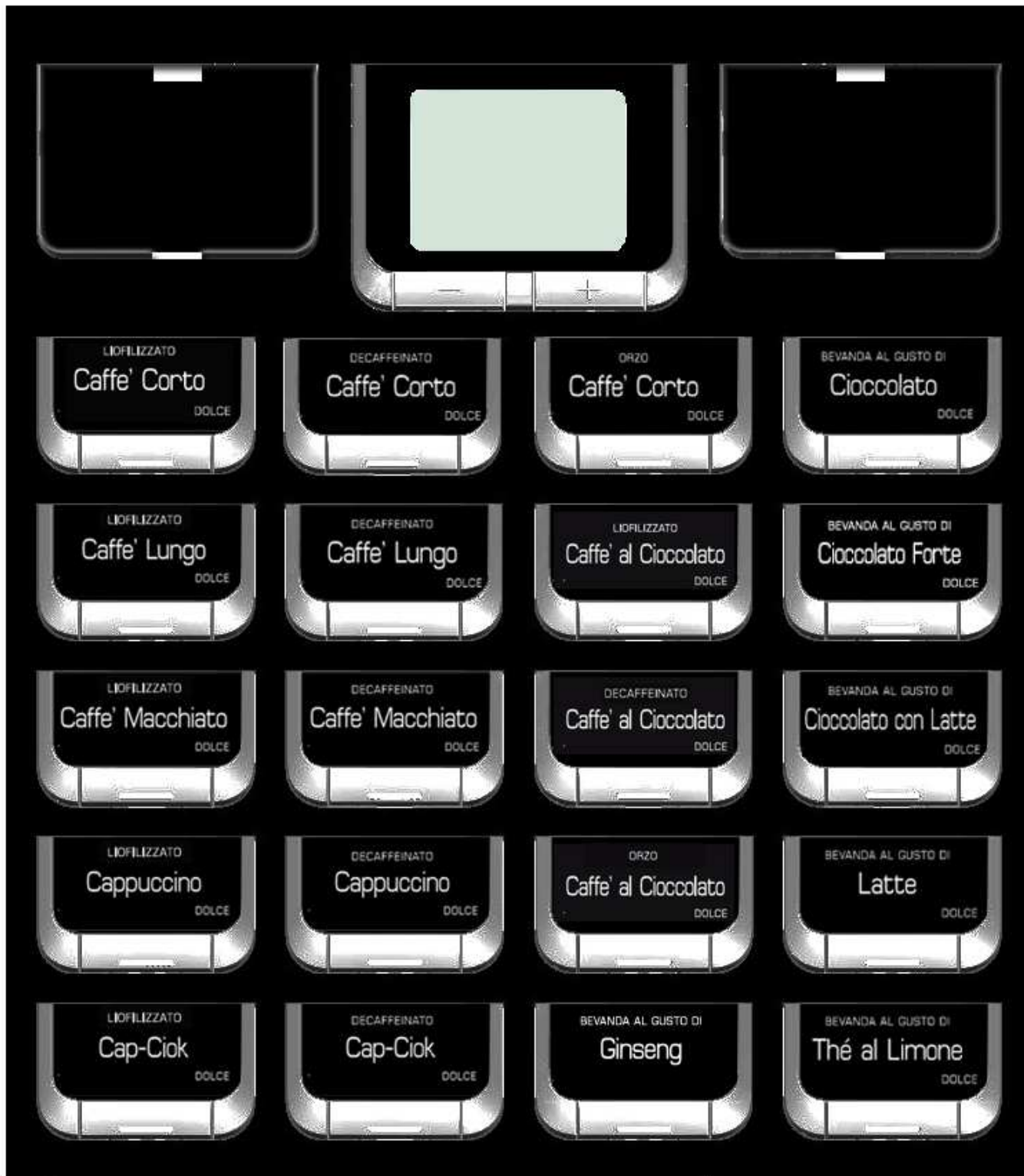

Fig. 31

Standard product configuration

1 GRINDER

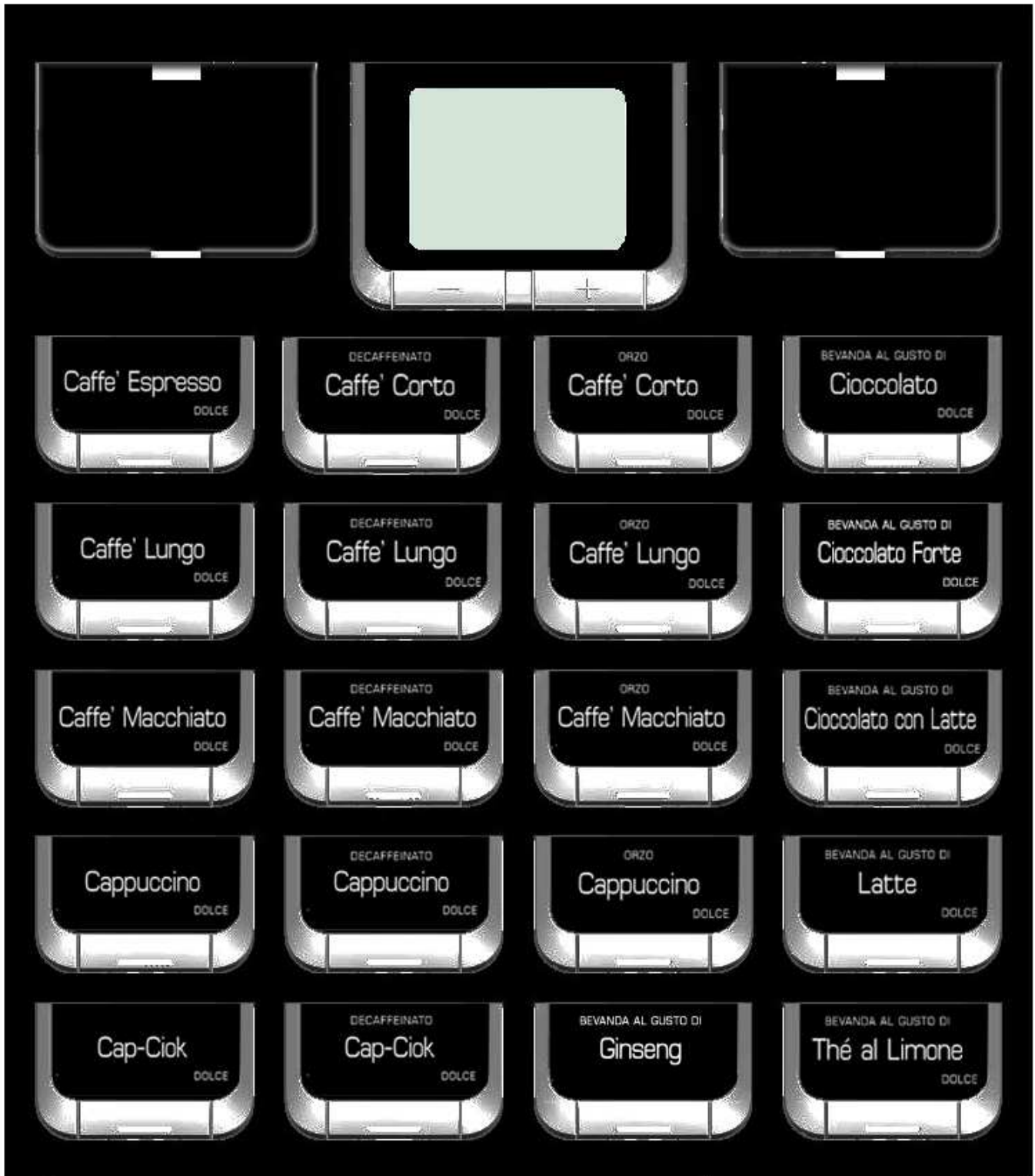

Fig. 32

Standard product configuration

2 GRINDERS



Fig. 33

Instruction plates

Loosen the two upper knobs (Fig. 27), remove the protection (Fig. 28) and release the transparent protections by pressing on the internal retainers (Fig. 34).

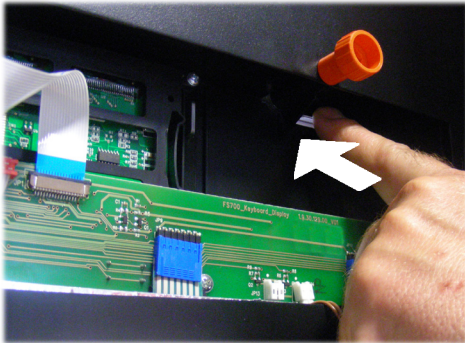

Fig. 34

Place the plates on the transparent protections and fit them back on the keypad panel (Fig. 35).



Fig. 35

5.5 Fitting the coffee grounds bag



Remove the clip from the grounds discharge channel (Fig. 36).

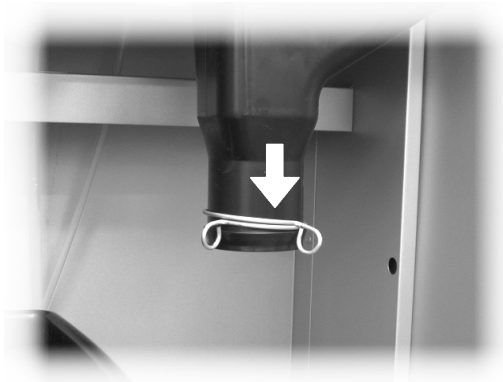

Fig. 36

Slip the clip into the coffee grounds bag (capacity of 50 litres) (Fig. 37).



Fig. 37

Place the bag on the channel (Fig. 38).

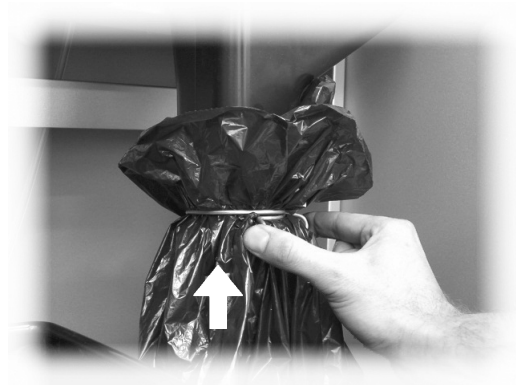

Fig. 38

5.6 Fitting the payment systems



The vending machine is designed for the installation of various payment systems, such as:

- parallel banknote reader 24V DC;
- parallel validator 24V DC
- executive systems (also PRICE HOLDING);
- MDB systems;
- BDV systems;
- cancelling machine 24V DC;
- parallel validator 12V DC (*);
- tokens acceptor 12V DC (*);

(*) optional kit required.

**Important**

The vending machine is not supplied with any payment system, which must be installed by the person in charge of its fitting.

After the chosen payment system has been installed, the corresponding parameters can be set through the programming menu (see 8.2).

To assemble the external antenna for the Contactless payment systems it is recommended to drill the holes in the area shown in Fig. 39.



Fig. 39



Fig. 40

**Warning**

The Manufacturer declines any liability for any damage to the vending machine, to property and/or injury to persons, caused by the installation of the payment system. The responsibility falls to the person who carried out the installation.

5.7 Connection to water mains**Important**

It is recommended to use a descaling device for the water network supplying the vending machine, especially for water with a high calcium and magnesium content (hard water). Connect the vending machine to drinking water mains with pressure between 0.15 MPA and 0.8 MPA (1.5 and 8 bar), see data on the label.

Remove the cap from the coupling placed on the vending machine back panel (Fig. 40). Connect the water network hose (supplied with the appliance) to the vending machine 3/4" Gas coupling (Fig. 40).

5.8 Connection to the electric network**Warning**

The Maintenance Technician, who is responsible for the installation of the vending machine, must ensure that:

- the electric system complies with current safety regulations;
- the supply voltage corresponds to that indicated on the data plate.

If in doubt, do not proceed with the installation and ask qualified and authorized personnel to check the system accurately.

The vending machine is equipped with a power cord which must be plugged into the appropriate socket on the vending machine back panel (Fig. 41).



Fig. 41

Do not use adapters or multi-sockets (Fig. 42).



Fig. 42

6 CONTROLS DESCRIPTION

6.1. Display

The display (2 - Fig. 1) shows the messages during standard operation, programming and maintenance modes.

6.2. Keypad

Important

Each key function changes according to the vending machine mode (ordinary dispensing or programming mode).

Each key has a double function that varies according to the vending machine status (standard operation or programming).

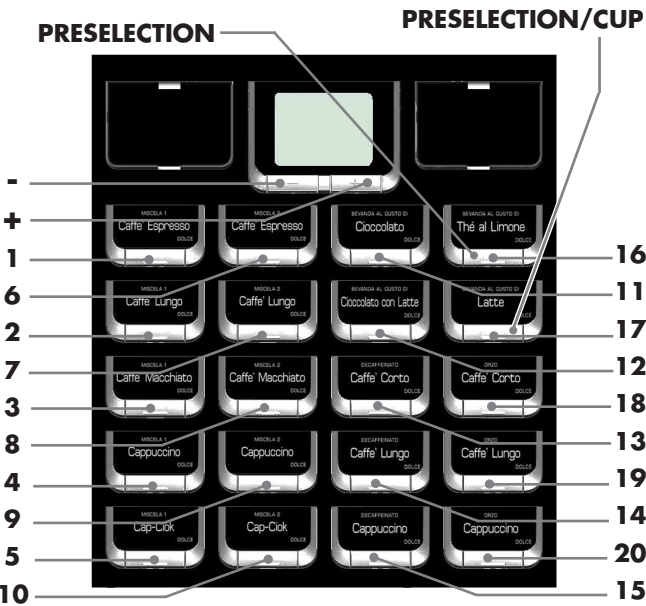

Fig. 43

6.3. Key description in standard operation mode

“+” Key - Sugar Quantity (Fig. 43)

Increases the quantity of sugar in the selected beverage. Press the key before selecting the beverage. The preselection remains active for 8 seconds.

“-” Key - Sugar Quantity (Fig. 43)

Decreases the quantity of sugar in the selected beverage. Press the key before selecting the beverage. The preselection remains active for 8 seconds.

Preselection Key (Fig. 43)

The functions associated with the preselection key can be selected from the following (page 36):
 A. Pre-selection of beverages 21-35 and 37-40
 B. Beverage 16
 C. Disabled

Preselection/Cup Key (Fig. 43)

The functions associated with the preselection/cup key can be selected from the following (page 36):
 A. Preselection cup
 B. Beverage 17
 C. Pre-selection of beverages 41-55 and 58-60
 D. Disabled

Keys (1 to 20 - Fig. 43)

By pressing these keys, the programmed beverages are dispensed.

6.4. CPU card keys

The CPU electronic card has 4 keys enabling the Maintenance Technician to carry out programming or maintenance operations (Fig. 44).

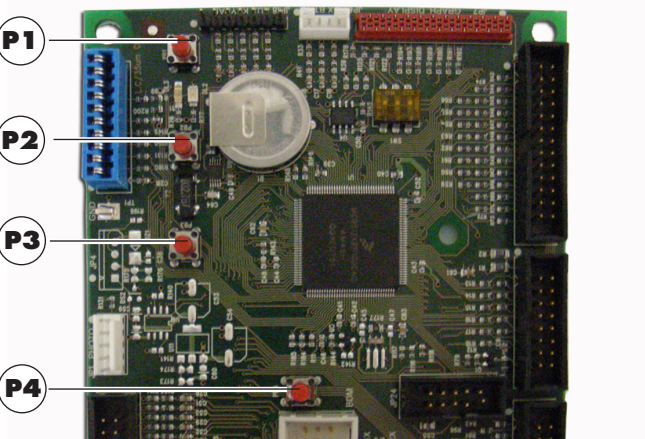

Fig. 44

7 SUPPLY AND STARTING UP

7.1 Container supply (Instant)



Important

The containers delivered are designed to dispense the following products (Fig. 45):

- Instant product 1** = Tea
- Instant product 2** = Chocolate
- Instant product 3** = Barley
- Instant product 4** = Milk
- Instant product 5** = Instant product of your choice
- Instant product 6** = Decaffeinated coffee
- Instant product 7** = Sugar
- Instant product 8** = Freeze-dried coffee

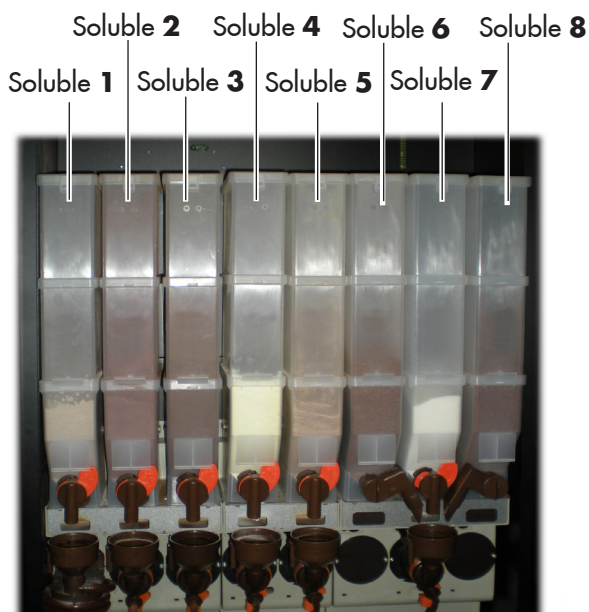

Fig. 45

7.2 Container supply (Single Grinder)



Important

The containers delivered are designed to dispense the following products (Fig. 46):

- Instant product 1** = Tea
- Instant product 2** = Chocolate
- Instant product 3** = Decaffeinated coffee
- Instant product 4** = Milk
- Instant product 5** = Barley
- Instant product 6** = Instant product of your choice

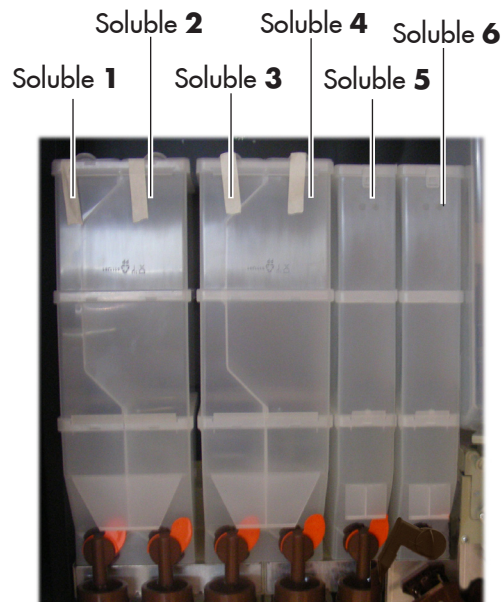

Fig. 46

7.3 Container supply (Double Grinder)



Important

The containers delivered are designed to dispense the following products (Fig. 47):

- Instant product 1** = Tea
- Instant product 2** = Chocolate
- Instant product 3** = Decaffeinated coffee
- Instant product 4** = Milk
- Instant product 5** = Barley

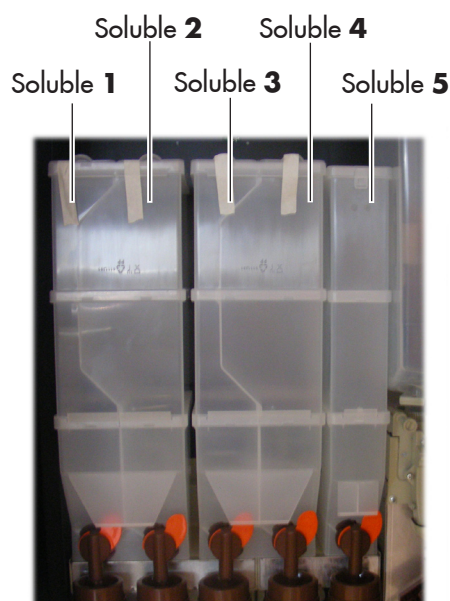

Fig. 47

7.3.1 Instant product supply



Open the cover of the container to be supplied (Fig. 48).



Fig. 48

Pour the instant product into the container (Fig. 49).



Fig. 49

Close the container cover.

7.3.2 Sugar supply



To refill the Instant version vending machine with sugar, fill the seventh instant product container as explained in section 7.3.1. For the espresso versions, perform the following operations:

Lift the cover of the sugar container located next to the stirrer dispenser and fill the container with sugar (Fig. 50).

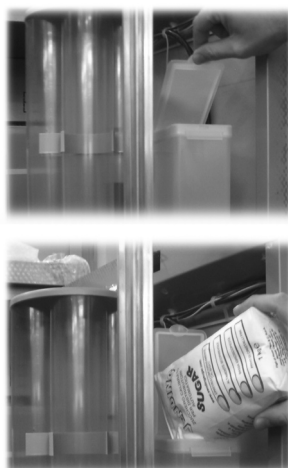

Fig. 50

Close the container cover.

7.3.3 Coffee bean supply



Remove the container cover (Fig. 51).



Fig. 51

Put coffee beans into the container (Fig. 52).



Fig. 52

Replace the cover on the container.

For the double coffee grinder version, the operation described above must be repeated for both the containers using different coffee blends.



Important

If the message "COFFEE NOT AVAILABLE" is displayed after the supply, the following operations should be carried out:

- press the **P2** key (Fig. 44) to enter the maintenance menu;
- press the key "**e**" twice (Fig. 65) to eliminate the error (see sect. 8.3.3 Description of messages in the maintenance menu).

7.4 Dose calibration



The vending machine is delivered with standard calibration values set by the manufacturer. The quantity of coffee powder is set to 7.0 gr.

Dose calibration can be performed by means of two calibration levels:

- remove the cover (Fig. 53);



Fig. 53

- release the adjusting lever from the rack and place the dragging tooth of the inner panel on one of the 4 positions available, which indicate the basic quantity area (6 gr. – 7 gr. – 8 gr. – 9 gr.) (Fig. 54);

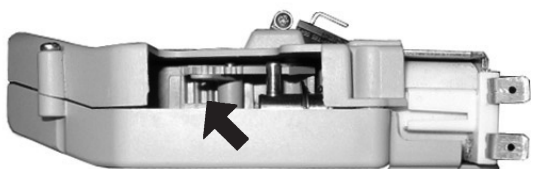

Fig. 54

- move the adjusting lever into the rack and select the slot corresponding to the dose required (Fig. 55).

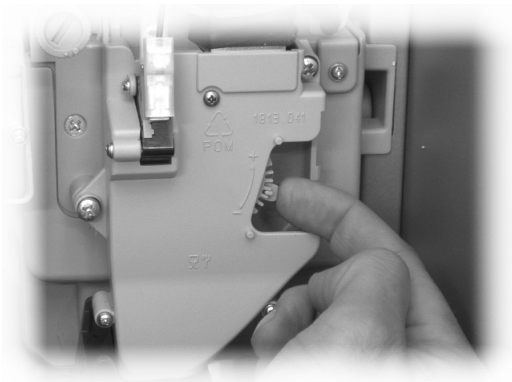

Fig. 55

7.5 Coffee grinding calibration



Turn the ring (Fig. 56) until the required results are obtained.

After any calibration three selections are necessary before the new setting becomes effective.

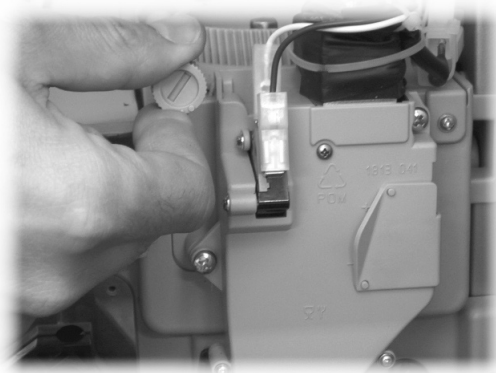

Fig. 56

7.6 Setting the water capacity for instant product solenoid valves



To get a good quality of drinks, it is crucial to properly adjust the brewing flow capacity. The machine is delivered with a standard adjustment which ensures its correct operation. For this reason, the brewing capacity is to be adjusted only when solenoid valves are replaced or when personalized settings are carried out.

To adjust the solenoid valve capacity turn the flow regulating screw (fig. 57). Turn it clockwise to reduce water capacity or anti-clockwise to increase it.

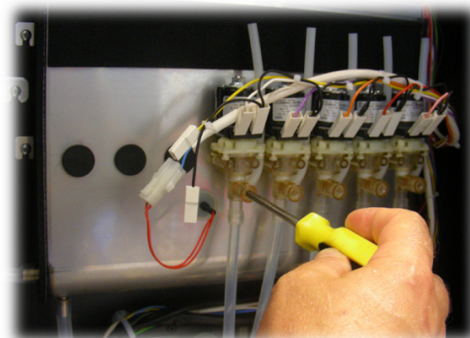
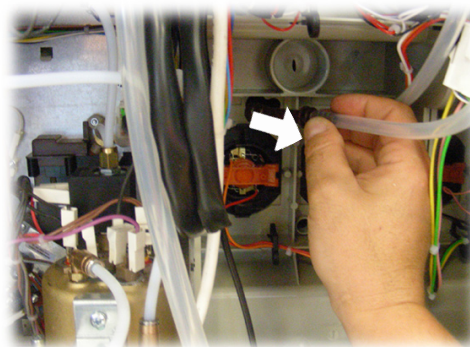

Fig. 57

In the maintenance menu, a specific item (see section 8.3.3) helps carry out the adjustment by keeping the solenoid valve open for a fixed time of 10". To adjust a solenoid valve for instant products, proceed as follows:

- 1) Enter the WATER TEST menu (see section 8.3.3).
- 2) Withdraw the dispensing spouts (Fig. 57);
- 3) Place a container under the brewing spouts.
- 4) Select the required solenoid valve through the UP/DOWN keys.
- 5) Press ENTER.
- 6) The chosen solenoid valve will remain open for 10". To get the correct flow, 90 cc of water should come out in 10 secs.

If the quantity is not correct, turn the flow regulating screw (fig. 57) and repeat the procedure from point 4.

7.7 Stirrer supply



Important

Use stirrers suitable for automatic vending, without imperfections and conforming to the dimensions indicated in 2.4 Technical Specifications.

- Remove the metal counterweight from the stirrer guides (fig. 58).



Fig. 58

- Introduce the stirrers with their packing band into the column (fig.59); once they are placed on the bottom, cut and remove the band (fig. 60).

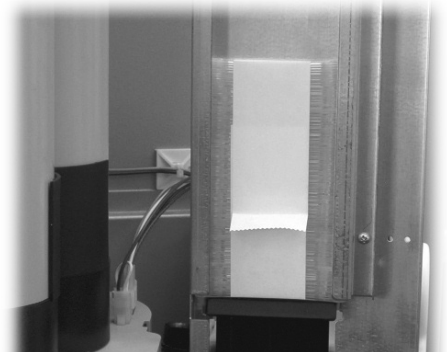

Fig. 59



Fig. 60

- When loading is complete, reinsert the metal counterweight (fig.61).

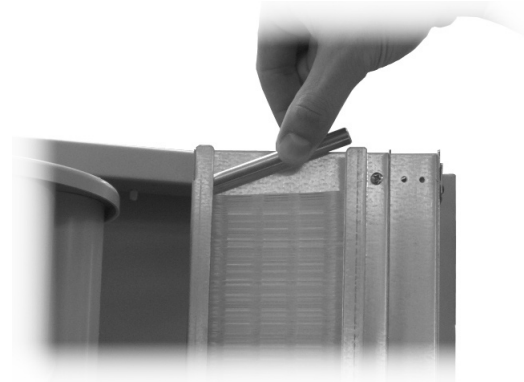

Fig. 61

Make sure the stirrers have no burrs, are not bent and are all placed horizontally.

7.8 Cup supply



Use only cups suitable for automatic vending - 70-71 mm diameter - and avoid compressing them while loading.



Important

Do not try to turn the column manually.

When installing, with the cup dispenser empty, proceed as follows:

- remove the cover of the cup dispensing tube (fig.62).

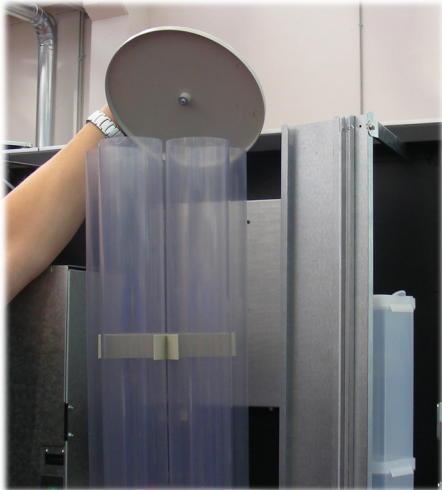

Fig. 62

- load two of the most accessible tubes (fig. 63).



Fig. 63

- replace the cover on the cup columns.

7.9 First start-up of the vending machine



Supply the vending machine (following the instructions given previously) and plug it into the power supply (see 5.8).

At this point the message **"ATLANTE"** will appear on the display and the self-diagnosis phase is activated to check the correct positioning of the machine devices.

During the self-diagnosis phase, the following devices are activated:

- the brew group, the nozzle arm and the stirrer/sugar dispenser, to get a correct starting positioning;
- if necessary, also the cup release motor and the cup holder will be activated

Instant products and coffee boilers are refilled also during the initialisation phase (*).

When the initialisation is complete the warming phase starts and the heating elements of the boilers are automatically switched on.

(*) During the initial start-up of the machine make sure the boilers are actually full by starting the Maintenance and performing a refill of the coffee boiler and a wash cycle

Perform the grinder adjustment as indicated in the instructions at point 7.5 after refilling the water circuit.

7.10 Water circuit filling



When the VM is first switched on, it is necessary to fill the boilers. The instant product boiler is filled automatically, while the Coffee boiler has to be filled manually using the appropriate "BOILER FILL" item of the maintenance menu.



Important

Before powering the machine, thus starting the automatic installation make sure that the water softener is filled with water and the air bubbles are removed.

7.10.1 Automatic filling of the instant product boiler

When switched on, the vending machine fills the instant product boiler automatically. This operation takes few minutes. If the filling of the boiler is not successful, the machine cannot be set into service. The "BOILER FILL ERR24" message will be shown on the display. Should it be the case, eliminate the trouble and repeat the automatic installation, after repairing the failure (11.2 Error messages). No heating is started until the instant product boiler is completely full. When the automatic filling is over, the warming phase starts to last 15 to 20 minutes.



Important

Compress the hose connecting the boiler to the water tank several times; keep on doing so until the air bubbles which may have formed have been eliminated (Fig. 64).

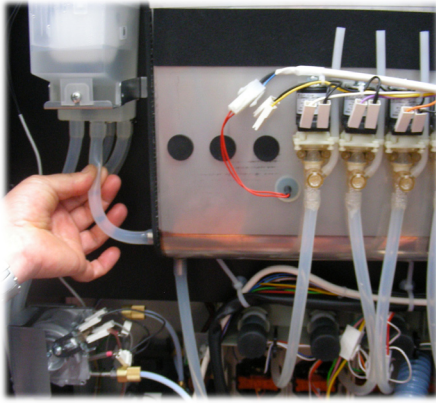

Fig. 64

7.10.2 Filling the coffee boiler manually



Manual filling of the boiler is required during the first start-up of the vending machine.

After switching the vending machine on it is possible to fill the boiler by activating the following procedure:

- press the **P2** key (Fig. 44) to enter the maintenance menu;
- press the "e" key (Fig. 65) followed by the **UP** key (+ - Fig. 65) to access the RINSING entry;
- press the button "e" (Fig. 65) to start the automatic filling cycle.



Important

Once the boilers are full, rinse the mixers to remove any residue in the water circuits until water comes regularly out of the dispensing nozzles.

7.11 Cleaning the parts in contact with foodstuffs



Clean all the parts of the VM which are in contact with foodstuffs.

- Wash your hands carefully.
- Prepare a chlorine-based anti-bacterial cleaning solution (these products can be purchased at the chemist's) following the concentrations indicated by the product instructions.
- Remove all the product containers from the vending machine.
- Remove the container lids and the product channels. Plunge all items into the previously prepared solution.

7.12 Use of the vending machine



Important

The instructions for use are shown on the plate on the front of the vending machine.

The beverage selection procedures are shown in section 9.

8 PROGRAMMING AND MAINTENANCE MENU



Important

This section illustrates how to set up or modify the vending machine programming and maintenance settings.

It is therefore necessary to read it carefully, and intervene only when the correct sequence of operations to be performed is fully understood.

8.1 Key description of programming and maintenance phases



To scroll through the vending machine menu, the keys described below are used.

“e” Key: ENTER (4 - Fig. 65)

By pressing this key it is possible to enter the following programming or maintenance level. It is also possible to modify or confirm the values set in the entries of the programming or maintenance menus.

“c” Key: CANCEL (3 - Fig. 65)

By pressing this key it is possible to go back to the previous level of the programming or maintenance menu. It is also possible to avoid storing the previously modified values.

“V” Key: DOWN (2 - Fig. 65)

Pressing this key it is possible to access the previous entry inside the same level.

If used after a setting modification request, the value of this setting decreases.

“^” Key: UP (1 - Fig. 65)

By pressing this key it is possible to access the next entry inside the same level.

If used after requesting the change of a setting, the value of this setting increases.

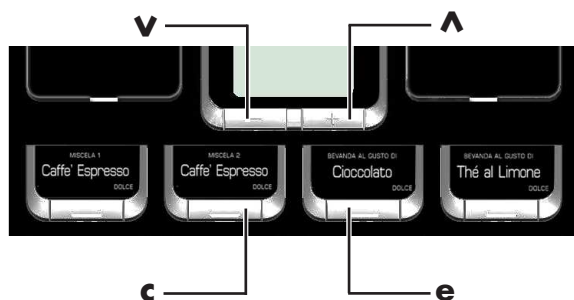

Fig. 65

8.2 Programming menu

The structure of the programming menu is shown in 8.2.2.

8.2.3 describes all the entries in the programming menu.

8.2.1 Entering the programming menu



Open the door, disable the safety device (see 3.4) and press the **P1** key (Fig. 66) to enter the programming menu.

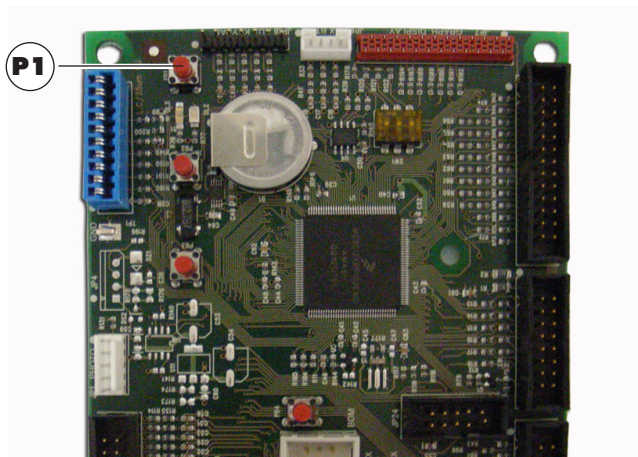

Fig. 66

If no password has been assigned, the programming menu is entered directly.



Important

If a password was assigned to the vending machine to enable the programming menu, the message “PASSWORD 000000” will appear on the display with a flashing cursor on the first digit.

Now the password should be entered using the UP and DOWN keys. Confirm the digit entered by pressing the ENTER key.

Proceed as follows to exit the programming menu and return to standard operation of the vending machine:

- Press the CANCEL button repeatedly until “EXIT ?” appears. Select YES and press ENTER;
- remove the key from the safety switch in order to turn off the vending machine;
- close the door and wait for the self-configuration process to end.

8.2.2 Structure of the programming menu

1.	System Management	1.22.	Language	2.4.6.	Max Change
1.1.	VM Code	1.23.	Disp. Outlet Check	2.4.7.	Exact Change Policy
1.2.	Stop	1.24.	Change Password	2.4.8.	Min Tube Level
1.2.1.	Coffee 1 Stop	1.24.1.	Password	2.4.9.	Manual Tube Filling
1.2.2.	Coffee 2 Stop	1.25.	On/Off Time	2.4.10.	Manual Tube Empty
1.2.3.	Beverage Stop	1.25.1.	On 1	2.4.11.	Commit to Vend
1.2.4.	Reset	1.25.2.	Off 1	2.4.12.	Bill Enablings
1.3.	Step Down Counters	1.25.3.	On 2	2.4.13.	Bill Escrow
1.3.1.	Last Filter Change	1.25.4.	Off 2	2.4.14.	MDB Slave Address
1.3.2.	Remaining Qty	1.26.	EVA-DTS	2.5.	Max Credit
1.3.3.	Filter Limit	1.26.1.	EA1..2 (Events)	2.6.	Multivend
1.3.4.	Filter Reset	1.26.2.	EA3..5 (Readouts)	2.7.	Overpay Time
1.3.5.	Filter Enabled	1.26.3.	LA1-Prices Lists	2.8.	Fixed Zeroes
1.4.	Min. Temperature	1.26.3.1.	LA1 Normal Prices	2.9.	Decimal Disits
1.5.	Max. Temperature	1.26.3.2.	LA1 Diff Prices 1	3.	Product Setup
1.6.	Soluble Temperature	1.26.3.3.	LA1 Diff Prices 2	3.1.	Product Before
1.7.	Wash Cycle	1.26.3.4.	LA1 Card Prices	3.2.	Beverage Enablings
1.8.	Pre-Grinding	1.26.3.5.	LA1 Free	3.3.	Beverage Preparation
1.9.	Soluble Preheating	1.26.3.6.	LA1 Test	3.4.	Sugar Pre-wash
1.9.1.	Soluble	1.26.4.	PA1..4 Products	4.	Sale Management
1.10.	Coffee Preheating	1.26.5.	VA1..3 Sales	4.1.	Price Table
1.10.1.	Preheating Type	1.26.6.	BA1-CA15-Cash	4.1.1.	Price
1.11.	Programmable Texts	1.26.7.	DA1..7-CashLess	4.2.	Beverage Prices
1.11.1.	Standby	1.27.	Cup Sensor	4.2.1.	Normal
1.11.2.	Dispensing	1.28.	Complete Menus	4.2.1.1.	Global Price
1.11.3.	Group1 Preselection	2.	Payment System	4.2.1.2.	Single Prices
1.11.4.	Group2 Preselection	2.1.	Protocol	4.2.2.	Differentiated 1
1.11.5.	Out Of Service	2.2.	Parallel Coiner	4.2.3.	Differentiated 2
1.12.	Display Contrast	2.2.1.	Enable	4.2.4.	Card
1.13.	Stirrer	2.2.2.	Coin Values	4.2.4.1.	Card Prices
1.14.	Pulse Counter	2.2.2.1.	Coin	4.3.	Free
1.15.	Clock	2.3.	Banknote Validator	4.4.	Free On
1.15.1.	Time	2.3.2.	Inhibition Level	4.5.	Free Off
1.15.2.	Date	2.3.3.	Banknote Value	4.6.	Diff. Prices 1-On
1.16.	Multiple Beverage	2.3.3.1.	Banknote	4.7.	Diff. Prices 1-Off
1.16.2.	Enable Multiple Bev.	2.4.	MDB Settings	4.8.	Diff. Prices 2-On
1.17.	Reset Enablings	2.4.1.	Recharge Enabled	4.9.	Diff. Prices 2-Off
1.18.	Free Vend Key	2.4.2.	Max Card Recharge		
1.19.	Key for Beverage 17	2.4.3.	Max Card Value		
1.20.	Key for Beverage 18	2.4.4.	Coins Enablings		
1.21.	Disp. Outlet Micro	2.4.5.	Alt. Payout		

8.2.3 Description of messages in the programming menu

```
1.
System management
...
```

SISYSTEM MANAGEMENT
The SYSTEM MANAGEMENT items are:

```
1.1.
VM Code
531000
```

VM Code
Enables an identification code to be assigned to the vending machine.

```
1.2.
Stops
...
```

Stops
Enables setting of the maximum amount of beverage or coffee. Once the maximum amount is reached, the vending machine stops dispensing the relevant beverages. The first digit on the left ("00000") refers to the quantity of product dispensed since the last "RESET" (partial counters).

The right hand digit, preceded by "LIM", shows the maximum dispensable quantity (value may be modified).

```
1.2.1.
Coffee 1 Stop
```

STOP COFFEE 1
Enables setting of the maximum number of coffee cups to be dispensed before the stop.

```
1.2.2.
Coffee 2 Stop
```

STOP COFFEE 2
Enables setting of the maximum number of coffee cups to be dispensed before the stop.

```
1.2.3.
Beverage Stop
```

STOP BEVERAGES
Enables setting of the maximum number of beverages to be dispensed before the stop.

```
1.2.4.
Reset
...
```

RESET
Enables resetting of all partial counters relative to product quantity stop functions.

```
1.3.
Step Down Counters
...
```

Step down counters
(Only if Complete Menus are enabled) Allows the use of the water filter to be checked.

```
1.3.1.
Last Filter Change
```

LAST FILTER CHANGE
Date of the last filter reset.

```
1.3.2.
Remaining Qty
```

REMAINING QTY
Number of litres of water that can still be dispensed before the filter needs to be

regenerated. When this value is less than 1, a Warning (W83) is recorded in the Error LOG.

```
1.3.3.
Filter limit
100
```

FILTER LIMIT
Number of litres of water that can still be dispensed from the filter.

```
1.3.4.
Filter reset
```

FILTER RESET
Select YES to indicate a new filter has been installed. This operation returns "Remaining Qty" to the same value as "Filter Limit" and the date in the "Last Filter Change" is changed to today's date.

```
1.3.5.
Filter enabled
```

FILTER ENABLED
Enables management of the "Remaining Qty" countdown.



Important

From the maintenance menu (button P2 on the CPU), you can access "Water Filter", "Last Filter Change", "Remaining Qty" and "Filter Reset".

```
1.4.
Min. temperature
00
```

Min. temperature
Enables setting of the temperature to be maintained for a few minutes by the vending machine after a

beverage has been dispensed. The set value is expressed in centigrade.

```
1.5.
Max. temperature
000
```

Max. temperature
Enables setting of the temperature to which the vending machine is brought

after a certain time from the last dispensing, in order to compensate for the natural decrease of the temperature of the hydraulic circuits. The set value is expressed in centigrade.

```
1.6.
Soluble Temperature
000
```

Soluble min temp
Allows setting the working temperature for the instant products boiler

```
1.7.
Wash Cycle
yes
```

Rinsing Cycle
It allows enabling of the automatic rinsing of the mixing bowls.

The automatic rinsing is performed as follows: the first rinsing takes place 10 minutes after the "machine ready" status; if necessary, other rinses occur 7 hours after the last dispensing.

```
1.8.
Pre-grindins
      yes
```

Pre-grinding

Enables instant pre-grinding of the coffee dose.

```
1.9.
Soluble Preheating
      yes
```

Preheat. solubles

Enables selection of the instant products for which the preheating function will

be enabled.

By enabling this function, the vending machine performs a preliminary dispensing of water through the circuit corresponding to the instant product selected. The user can choose for which instant product preheating can be enabled, by setting cu cm of water to be used.

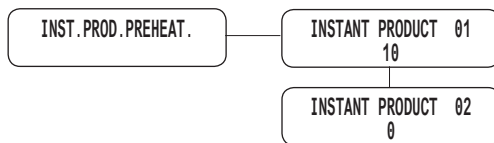

Example: the settings shown in the figure enable preheating for instant product 1 with 10 units of water and do not enable preheating for instant product 2.

Instant product preheating takes place if:

- at least 3 minutes have passed since the mixing bowl was last used;
- the quantity of water for the instant product is < 50 units.

```
1.10.
Coffee Preheating
      00
```

Coffee preheating

It allows enabling a preheating cycle of the Brew Group if it remains inactive

for a period of time.

```
1.10.1.
Preheating Type
```

PREHEATING TYPE

Enables or disables brew group preheating by a puff of steam. Such preheating

makes the machine reach the ideal temperature before dispensing coffee after a break.

The "Light" setting is suggested for locations with a room temperature above approx. 22 C°, while the "Strong" setting is suggested for locations with a room temperature below approx. 22 C°.

```
1.11.
Programmable Texts
      ...
```

Programmable texts

```
1.11.1.
Standby
** ATLANTE **
```

STAND-BY TEXT: it enables setting the message appearing on the display when the vending machine is in standard operating mode.

```
1.11.2.
Dispensing
```

DISPENSING TEXT: it allows setting the message appearing on the display when the vending machine is dispensing a product.

```
1.11.3.
Group1 Preselection
```

SET 1 PRE-SELECTION

Allows setting the display message when the pre-selection mode of the button

16 is activated for beverages 21-35 and 37-40.

```
1.11.4.
Group2 Preselection
```

SET 2 PRE-SELECTION

Allows setting the display message when the pre-selection mode of the button

17 is activated for beverages 41-55 and 58-60.

```
1.11.5.
Out of service
Chiama assist.
```

OUT OF SERVICE TEXT: it enables setting the text on the display when the vending machine stops due to a fault.

```
1.12.
Display Contrast
```

Contrast

Adjusts the contrast of the display.

```
1.13.
Stirrer
```

Stirrer

Enables selection of the stirrer dispensing mode.

STIRRER ALWAYS: the stirrer is dispensed anyway;

STIRRER SUGAR: the stirrer is dispensed only if the beverage is served with sugar;

STIRRER SUGAR or BITTER: the stirrer is dispensed for all the beverages which should be served with sugar, although the user requires them without it.

```
1.14.
Pulse Counter
```

Coffee / beverage pulse counter

Enables selection of whether the 24V dc electromechanical pulse counter (optional – to be connected to the CPU card) has to count the coffees or all dispensed beverages.

1.15.
Clock
...

Clock

Enables setting of the hour, minute, day of the week, day of the month, month and year.

1.15.1.
Time
08:00

1.15.2.
Date
01 Gen 08

1.16.
Multiple Beverage
...

Multiple beverage

Allows selecting which beverages will be enabled for multiple brewing and the number of brewings.

1.16.1.
Multiple Beverage
000

1.16.2.
Enable Multiple Bev.

1.16.2.
Beverage 1
Yes

1.17.
Reset Enablins
No

Enable reset

It allows enabling of the "RESET" for data in the statistics maintenance menu.

1.18.
Free Vend Key
No

Free vend key

It enables the **P3** key of the CPU card for free dispensing of a product during standard operation.

1.19.
Key for Beverage 17
..

Beverage 17 key

The functions associated with the Beverage 17 key can be selected from the following:

- A.** Preselection cup
- B.** Beverage 17
- C.** Set 2 pre-selection (beverages 41-55 and 58-60)
- D.** Disabled

A - PRESELECTION CUP: if this option is enabled, a beverage without cup can be obtained by pressing the CUP key before choosing a beverage. After the preselection key is pressed, the user has 8 seconds to select the desired product. After 8 seconds, the preselection is cancelled.

PRICE SETTING - Cup price can be set only if cup preselection is activated. To set, go to PROGRAMMING - CUP PRICE in the PRICE MANAGEMENT menu.

COUNTERS AND STATISTICS - If cup preselection is activated, the VM will calculate the cost of the product based on two components: beverage + cup; the operator will therefore have to set the price of both components. The amount paid by the user for each product with cup is given by the sum of the beverage price plus the cup price. A practical example is given below.

If: price level 1 = 0.50 and price level 2 = 0.05

	Beverage Price	Cup Price	Final Cost	Increased Counters
Beverage with cup	Level 1	Level 2	0.55	Beverage counter and cup counter
Beverage without cup	Level 1	Level 2	0.50	Beverage counter

BEVERAGE COUNTER - If the product is dispensed with the cup, the following will be added to statistics: 1 stroke for the beverage at price level 1 (0.50), 1 price increase on cup price (0.05) and 1 cup dispensing.

Whereas if the product is dispensed without the cup, the following will be added to statistics: 1 stroke for the beverage at price level 1 (0.50) and 1 cup dispensed. The total amount of cup mark-ups is displayed in MAINTENANCE under CUP in the STATISTICS menu.

B - BEVERAGE: With this function the CUP key becomes a beverage key just like all the others. The operator can program the product in exactly the same way as a normal beverage. The CUP key is linked to beverage 17.

C - "PRESELECTION": by pressing this key, the vending machine displays the preselection message ("Preselection Y" as default) and makes another group of beverages available extending the beverages (or recipes) that the vending machine can dispense to a total of 54.

D - DISABLED: Pressing the key has no effect.

**Important**

The cup counter is updated for any single cup dispensed for whatever reason.

1.20.
Key for Beverage 16
Beverage

Beverage 16 key

The functions associated with the Beverage 16 key can be selected from the following:

- A.** Set 1 pre-selection (beverages 21-35 and 37-40)
- B.** Beverage 16
- C.** Disabled

A - PRESELECTION: by pressing this key the vending machine displays the preselection message and makes another group of beverages available.



Important

With this configuration it is necessary to set the new beverage/recipe group available (see the BEVERAGE BREWING menu).

B - BEVERAGE: by pressing this key the beverage/recipe 16 will be brewed.

C - DISABLED: pressing the key has no effect.

1.21.
Disp. Outlet Micro

Disp. outlet micro

It enables/disables checking if the dispensing outlet door has been opened (7 - Fig. 1).

By setting YES (default value), the dispenser will check, after each brewing, that the dispensing outlet door has been opened, before allowing another beverage to be dispensed.

By setting NO, no check will be performed.



Important

The VM operates with the dispensing outlet door always open if:

- 1- "DISPENSING OUTLET MICRO" is set to NO
- 2- the dispensing outlet microswitch wiring is short-circuited

1.21.
Language

Language

Enables selection of the language to be used by the vending machine. Languages

available: Italian, English, French, German, Spanish, Portuguese and Dutch.

1.23.
Disp. Outlet Check

Cup remove check

Allows cup detection inside the dispensing outlet.

1.24.
Change Password

Password change

Enables setting of a password or modification of the current one.

The password consists of a number between 0001 and 65536. The 0000 value (default value) means no password. To set the password, press UP and DOWN keys and confirm with the ENTER key.

1.24.1.
Password

PASSWORD PROG.

Allows setting a password to access the programming menu.

1.24.2.
Password serviz.

PASSWORD SERVIZ.

Allows setting a password to access the maintenance menu.

1.25.
On/off time
...

On/off time

Allows setting the vending machine's automatic on and off time ranges over the course of a week.

1.25.1.
On 1
Immevsd 00:00

1.25.2.
Off 1
Immevsd 00:00

1.25.3.
On 2
Immevsd 00:00

1.25.4.
Off 2
Immevsd 00:00

1.26.
EVA-DTS
...

EVA-DTS

Allows selecting the category of data that will be transferred by the VM during an Audit Eva Dts session.

1.26.1.
EA1..2 (Events)

1.26.2.
EA3..5 (Readouts)

1.26.3.
LA1-Prices Lists

1.26.3.1.
LA1 Normal Prices

1.26.3.2.
LA1 Diff Prices 1

1.26.3.3.
LA1 Diff Prices 2

1.26.3.4.
LA1 Card Prices

1.26.3.5.
LA1 Free

1.26.3.6.
LA1 Test

1.26.4.
PA1..4 Products

1.26.5.
VA1..3 Sales

1.26.6.
BA1-CA15-Cash

1.26.7.
DA1..7-CashLess

1.27.
CUP Sensor

Cup sensor

Enables management of the cup sensor.

1.28.
Complete Menus

Complete menus

Enables selection of whether the entries of the programming menu should be shown fully or only partially.

PAYMENT SYSTEMS

```
2.
Payment System
...
```

The entries of the PAYMENT SYSTEMS are:

```
2.1.
Protocol
...
```

Protocol

Enables selection of the protocol used by the vending machine to dialogue with the

payment system installed on it:

- EXECUTIVE protocol;
- PRICE HOLDING/DISP Protocol;
- BDV Protocol;
- MBD Protocol;
- NO PROTOCOL (no serial protocol);
- MDB SLAVE (the vending machine operates as slave to another machine);
- Master/Slave executive (the vending machine operates as master for another vending machine);
- PHD Master /Slave (the vending machine operates as master for another vending machine that works with the PRICE HOLDING/DISP protocol);
- MDB SLAVE (the vending machine operates as slave to another machine);

The "NO PROTOCOL" setting will be used when a payment system operating with one of the protocols provided by the other settings "EXECUTIVE", "PRICE HOLDING", "BDV", "MDB" "MDB SLAVE" or "EXEC MASTER/SLAVE" is not installed on the VM.

This setting is necessary since the VM continuously checks for dialogue with the provided payment system. If the VM detects no dialogue, it signals this fault on the display through the message "NO LINK".

This signal cannot be considered an error condition.

```
2.2.
Parallel Coiner
...
```

Coin validator

Allows enabling of the parameters of the parallel coiner, the mechanical coiner,

the cancelling machine and the choice of values to be assigned to the single money channels.

Entry description:

```
2.2.1.
Enable
No
```

ENABLE: By setting "Y", the parallel coiner, the mechanical coiner and the cancelling machine control are enabled.

By setting "N", a parallel coiner which may be connected to the vending machine is always disabled.

```
2.2.2.
Coin Values
...
```

```
2.2.2.1.
Coin 1/6
0.00
```

COIN VALUE: Enables setting of the value of the coins transferred to the vending machine from the parallel coiner, the mechanical coiner and the cancelling machine. The following table shows the channel/payment system combinations.

Channel	Payment system
1	Coin validator
2	Coin validator
3	Coin validator
4	Coin validator
5	Coin validator
6	Coin validator
7	Cancelling machine

```
2.3.
Banknote Validator
...
```

Banknote validator

It enables the parameters of the parallel banknote validator and the choice of values to be

assigned to single banknote channels.

Entry description:

```
2.3.1.
Enable
No
```

ENABLE: By setting "Y", the management of the parallel reader is enabled. By setting "N", a parallel reader which

may be connected to the vending machine is always disabled.

```
2.3.2.
Inhibition Level
255
```

INHIBITION LEVEL: Enables setting of the active level of the banknote reader inhibition signal.

```
2.3.3.
Banknote Value
...
```

BANKNOTE VALUE: Enables setting of the value of banknotes transferred to the vending machine from the parallel reader.

```
2.3.3.1.
Banknote 1/4
0.00
```

```
2.4.
MDB Settings
...
```

MDB settings

Enables access to particular functions of the MDB protocol.

```
2.4.1
Recharge Enabled
No
```

RECHARGE: Allows disabling or enabling of any Saeco card recharge operation.

By setting RECHARGE = NO the vending machine will only deduct the cost from MDB cards.

2.4.2. Max Card Recharge 10.00

MAX CARD LOAD: Enables setting of the maximum credit level, beyond which all recharge operations (if

enabled) are ineffective.

By setting MAX RECHARGE = 20.00, the credit on the vending machine will be transferred to the card if the sum does not exceed 20.00.

2.4.3. Max Card Value 10.00

MAX VALUE ACCEPTED: Enables setting of the maximum credit level, beyond which the card is rejected by

the system. By setting MAX CARD VALUE = 25.00, the vending machine will reject all cards with a credit which exceeds this amount. If this card is detected, the display will not show the credit but a "—" message will be displayed and no sale will be carried out.

2.4.4. Coins Enablings ...

COINS ENABLING: Enables selection of which coins will be accepted by the change-giving coiner. By setting "Y" a specific coin will be accepted. On the contrary, the "N" setting prevents the change-giving coiner from accepting

2.4.4.1. Coin 1/16 No

a particular coin. Coins beneath the vending machine scale factor are always disabled and display the "N" setting.

2.4.5. Alt. Payout No

ALT. PAYOUT: It enables/disables use of Alternative Payout for the level 3 MDB change-giver.

By setting "Yes" the change-giver is called on to dispense change. Change is limited to 255 times the scaling factor (typically € 12.75 for the Euro area - with scaling factor of 5).

By setting "No" change is given by exploiting the machine's algorithm. Max. change is 60000 units (typically € 600 for the Euro area).

2.4.6. Max change 0.00

MAX CHANGE: Enables setting of the maximum amount of change which can be dispensed by the change-giving coiner. Default = 10.00.

2.4.7. Exact change policy 0

EXACT CHANGE POLICY: In MDB change-giving coiners, the condition of no change available can be selected within the following table:

Key:

L = channel with the lowest coin value below the minimum level

M = channel with the medium-low coin value below the minimum level

HL = channel with the medium-high coin value below the minimum level

HH = channel with the highest coin value below the minimum level

No.	Description
0	L or M or HL or HH
1	L or M
2	HL or HH
3	L or HH
4	L
5	M
6	HL
7	L and HH
8	HL and HH
9	L and M
10	L and M and HL and HH
11	L and HL or L and HH
12	L or HL and HH
13	HH
14	L and M and HL
15	Never (change always available)

Note

Even if the no change available message is displayed, the vending machine continues to give change as long as coins are present in the channels. The minimum level (same for all channels) can be set on a special menu item.

2.4.8. Min Tube Level 0

MIN TUBES LEVEL: Enables setting of the minimum number of coins in the channels. Default = 4.

2.4.9. Manual Tube Filling ...

MANUAL TUBES FILLING: Allows the change-giving coiner channels to be filled manually. Press Esc to exit the channel loading mode.

2.4.10. Manual Tube Empty ...

MANUAL TUBES EMPTY: Allows the change-giving coiner channels to be emptied by pressing the beverage selection keys.

2.4.11 Commit to Vend No

COMMIT TO VEND: By setting "N", the credit inserted can be returned even if no sale has been made. This function may be useful, for example, for changing banknotes into coins. By setting "Y", the credit inserted can be returned as change only after the sale has been completed. Default = YES.

2.4.12 Bill Enablings ...

BILLS ENABLING: Enables selection of which banknotes will be accepted by the MDB banknote reader.

2.4.12.1 Banknote 1/16 No

A specific banknote is enabled for acceptance by setting "Y". On the contrary, the "N" setting prevents the banknote reader from accepting a

specific banknote. Default = All enabled.

```
2.4.13.
Bill Escrow
      No
```

BILLS ESCROW: By setting "Y", an inserted banknote is stored in the escrow position by the banknote reader (if supported); this function is supported by the banknote reader. In this way, if the sale fails or the card system fails to charge, the banknote will be returned. By setting "N", any inserted banknote goes to the banknote reader's stacker, so that the banknotes cannot be returned. Default = No.

```
2.4.14.
MDB Slave Address
      0x40
```

SLAVE ADDRESS: When the vending machine is in Master mode, this menu enables setting of the address of any slave connected vending machine. If the vending machine is in Slave mode, it enables setting of its address. Possible addresses are 0x40, 0x48 and 0x50. Default = 0x40.

```
2.5.
Max Credit
      2.55
```

Max credit
This allows the user to set the maximum credit which can be accepted by the vending machine. Once this limit has been reached, the payment systems are disabled so that no more credit can be accepted. Default = 20.00.

```
2.6.
Multivend
      No
```

Multivend
Enables the user to use any residual credit to purchase other beverages. By setting "N" (no), the residual credit will be collected by the vending machine.

```
2.7.
Overpay Time
      180
```

Overpay Time
It establishes the maximum time (expressed in seconds) beyond which the vending machine collects the displayed residual credit. The time is adjustable at intervals of 10 seconds. By setting "000" the function is disabled.

```
2.8.
Fixed Zeroes
      0
```

Fixed zeroes
Enables setting of the number of fixed zeros of the credit.

```
2.9.
Decimal Disits
      0
```

Decimal point posit.
Enables setting of the position of the decimal point of the credit.

```
3.
Product Setup
      ...
```

BEVERAGE BREWING

```
3.1.
Product Before
      ...
```

Product Before

It allows selecting the instant product for which you wish to enable powder dispensing before water dispensing. This brewing cycle will be carried out only when the quantity of powder to be brewed does not exceed 34.

```
3.1.1.
Soluble      1/7
No
```

```
3.2.
Beverage Enablns
      ...
```

Beverage Enabling

It allows to enable or disable the beverage keys. By pressing a disabled key during operation, the message "NOT AVAILABLE" will be displayed.

```
3.2.
Beverage      1
              Yes
```

The combination BUTTON - BEVERAGE NUMBER changes if buttons 16 and 17 are used as "PRESELECTION" buttons:

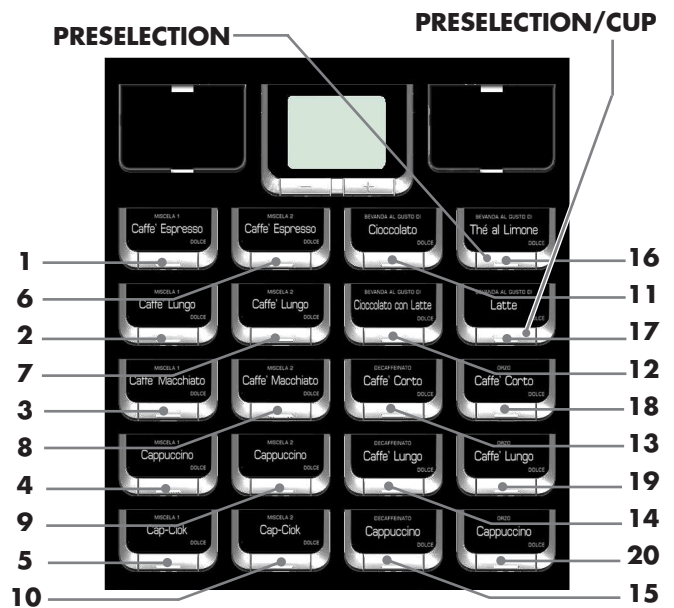

Fig. 67

KEY 16 and 17 = BEVERAGE 16 and 17

KEY	Press KEY
1	Beverage 1
2	Beverage 2
3	Beverage 3
4	Beverage 4
5	Beverage 5
6	Beverage 6
7	Beverage 7
8	Beverage 8
9	Beverage 9
10	Beverage 10
11	Beverage 11
12	Beverage 12
13	Beverage 13
14	Beverage 14
15	Beverage 15
16	Beverage 16
17	Beverage 17
18	Beverage 18
19	Beverage 19
20	Beverage 20

KEY 16 and 17 = PRESELECTION

KEY	Press KEY	Press PRESELECTION 16+KEY	Press PRESELECTION 17+KEY
1	Beverage 1	Beverage 21	Beverage 41
2	Beverage 2	Beverage 22	Beverage 42
3	Beverage 3	Beverage 23	Beverage 43
4	Beverage 4	Beverage 24	Beverage 44
5	Beverage 5	Beverage 25	Beverage 45
6	Beverage 6	Beverage 26	Beverage 46
7	Beverage 7	Beverage 27	Beverage 47
8	Beverage 8	Beverage 28	Beverage 48
9	Beverage 9	Beverage 29	Beverage 49
10	Beverage 10	Beverage 30	Beverage 50
11	Beverage 11	Beverage 31	Beverage 51
12	Beverage 12	Beverage 32	Beverage 52
13	Beverage 13	Beverage 33	Beverage 53
14	Beverage 14	Beverage 34	Beverage 54
15	Beverage 15	Beverage 35	Beverage 55
16	Preselection	-----	-----
17	Preselection	-----	-----
18	Beverage 18	Beverage 38	Beverage 58
19	Beverage 19	Beverage 39	Beverage 59
20	Beverage 20	Beverage 40	Beverage 60

**KEY 16 = PRESELECTION
KEY 17 = BEVERAGE 17**

KEY	Press KEY	Press PRESELECTION 16+KEY
1	Beverage 1	Beverage 21
2	Beverage 2	Beverage 22
3	Beverage 3	Beverage 23
4	Beverage 4	Beverage 24
5	Beverage 5	Beverage 25
6	Beverage 6	Beverage 26
7	Beverage 7	Beverage 27
8	Beverage 8	Beverage 28
9	Beverage 9	Beverage 29
10	Beverage 10	Beverage 30
11	Beverage 11	Beverage 31
12	Beverage 12	Beverage 32
13	Beverage 13	Beverage 33
14	Beverage 14	Beverage 34
15	Beverage 15	Beverage 35
16	Preselection	-----
17	Beverage 17	Beverage 37
18	Beverage 18	Beverage 38
19	Beverage 19	Beverage 39
20	Beverage 20	Beverage 40

**KEY 16 = PRESELECTION
KEY 17 = CUP**

KEY	Press KEY	Press PRESELECTION 16+KEY
1	Beverage 1	Beverage 21
2	Beverage 2	Beverage 22
3	Beverage 3	Beverage 23
4	Beverage 4	Beverage 24
5	Beverage 5	Beverage 25
6	Beverage 6	Beverage 26
7	Beverage 7	Beverage 27
8	Beverage 8	Beverage 28
9	Beverage 9	Beverage 29
10	Beverage 10	Beverage 30
11	Beverage 11	Beverage 31
12	Beverage 12	Beverage 32
13	Beverage 13	Beverage 33
14	Beverage 14	Beverage 34
15	Beverage 15	Beverage 35
16	Preselection	-----
17	Cup	-----
18	Beverage 18	Beverage 38
19	Beverage 19	Beverage 39
20	Beverage 20	Beverage 40

3.3.
Beverage Preparation

Beverage Preparation

The vending machine can brew 20 beverages in direct mode, or up to 54 beverages,

34 of which by means of the preselection. Each beverage can be prepared using coffee beans and/or instant products. The technician can select the desired products for the recipe (max 4) and order of use. Each component is identified by a number or a digit (Fig. 68).

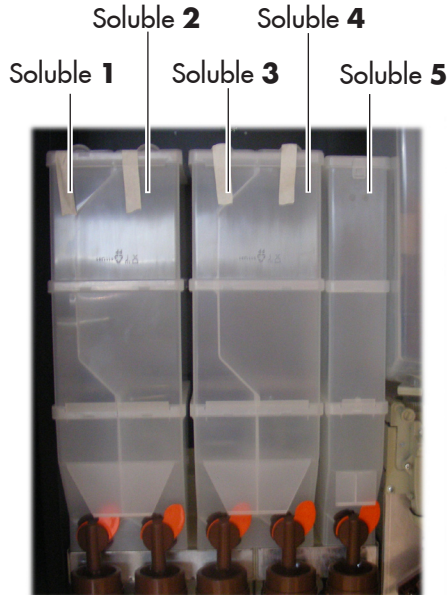

Fig. 68

3.3.
Beverage 1
...

SEQUENCE

This is the order in which the products making up the beverage are brewed. The possible choices are:

3.3.
Beverage 1
Sequence 0000

0 = does not dispense any product

1 = dispenses product 1

2 = dispenses product 2

3 = dispenses product 3

4 = dispenses product 4

5 = dispenses product 5

C = dispenses coffee beans from coffee hopper no. 2

K = dispenses coffee beans from coffee hopper no. 1

W = dispenses hot water

Consequently, the combination of "3C00" or "30C0" or "03C0" will always dispense product 3 and coffee beans. The settings of products making up the beverage will be requested according to the sequence.



Importante

Per ottenere l'erogazione del solo bicchiere, impostare a 0000 la sequenza della bevanda, e bloccare la regolazione dello zucchero (impostazione zucchero = "zucchero bloccato").

3.3.
Beverage 1
H2O/coffee 38

H2O / COFFEE

This defines the quantity of coffee to be brewed.

The quantity of dispensable coffee can be adjusted from "1" to "999".

3.3.
Beverage 1
Just water 101

JUST WATER

Defines the amount of hot water to be dispensed. The amount of coffee that can be brewed can be adjusted from "1" to "999".

3.3.
Beverage 1
% Instant product

% INSTANT PRODUCT

This defines the speed at which the instant powder and water are brewed (see chart).

Brewing speed of instant powder and hot water is adjustable from "10" to "120" in steps of 1.

By setting a value of "10", the pump works at the maximum capacity, while the instant product is brewed with impulses, at minimum capacity. Setting "100" both the instant product and water will be brewed at maximum capacity.

Setting "120" the pump works, with impulses at minimum capacity, while the instant product is brewed at maximum capacity.

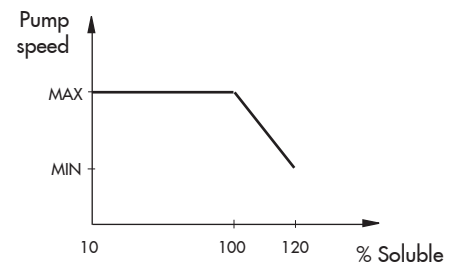
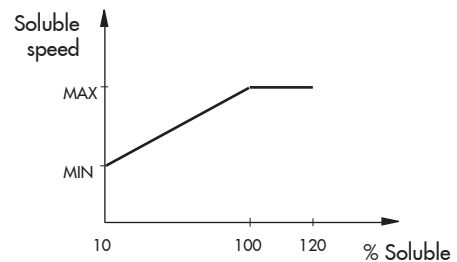

Important

If the sequence includes several instant products, the sequence "INSTANT PRODUCT - WATER - DELAY - INSTANT PRODUCTS - % OF INSTANT PRODUCT" will be shown again.



Important

If the setting relative to the instant product ("INSTANT PRODUCT - WATER - % INSTANT PRODUCT") means that the powder dispensing lasts longer than the water dispensing, the vending machine stops powder dosing (to avoid insufficient rinsing of the mixer) and emits a beep. Check the settings again to obtain correct dispensing (powder dispensing must end a few instants before the water dispensing is complete, to allow good rinsing of the mixer).

```
3.3.
Beverage      1
InstProd D. 3:005
```

INSTANT PRODUCT DOSE:
This defines the quantity of instant product to be brewed.

Example: "005" quantity indicates that the motor of the instant product 3 will be activated for 5 tenths of a second. The quantity of instant product is adjustable from "1" to "100" in steps of 1. Brewing of the instant product does not occur when the parameter is set at "0000" (in this case water is brewed).

```
3.3.
Beverage      1
H2O InstPr. 3:022
```

H2O / INSTANT PRODUCT
It defines the amount of water to be mixed with the instant powder.

Example: "3" indicates that water will be mixed with the instant product 3. "022" indicates that 22 water units will be brewed with the instant product. The reference unit is preset by the manufacturer. The amount of water can be adjusted from "1" to "999" in steps of 1.

```
3.3.
Beverage      1
Sugar         2
```

SUGAR
This defines the quantity of sugar to be dispensed with the beverage.

The following table shows the result of the various settings.

Settings	Sugar in beverage without preselection	Sugar in beverage with preselection
0	Without sugar	Quantity preselected
1	1	Quantity preselected
2	2	Quantity preselected
3	3	Quantity preselected
4	4	Quantity preselected
Stop sugar	Without sugar	Without sugar

```
3.3.
Beverage      1
Test Beverage
```

BEVERAGE TEST

Enables brewing tests to be carried out on the beverage just set.

By pressing ENTER the message "PRESS KEY" is displayed and it is possible to choose the key to be pressed, relative to the type of brewing test:

- Beverage 1 key = Complete beverage;
- Beverage 2 key = Beverage without sugar, stirrer and cups;
- Beverage 3 key = Beverage without powder (soluble/coffee);
- Beverage 4 key = Beverage without water.

```
3.4.
Sugar pre-wash
```

SUGAR PRE-WASH

Allows enabling/disabling the sugar cup pre-wash before dispensing the beverage.

This allows cleaning the cup from possible dark product particles in it.

Washing of the sugar cup (mixer) is performed under the following conditions:

- Functionality for the selected beverage enabled;
 - Beverage dispensed with sugar;
 - The sugar mixer has been last used to dispense one of the instant products located next to the sugar container.
- The quantity of water used for the wash is a factory preset value.

```
4.
Sale Management
...
```

SALE MANAGEMENT

The PRICE MANAGEMENT items are:

```
4.1.
Price table
...
```

Price table

99 price levels can be set.

```
4.1.1.
Price      1
          0.00
```

```
4.2.
Beverage Prices
...
```

Beverage price

Enables association of one of the price levels set in the PRICE TABLE to each beverage. The association can be:

```
4.2.1.
Normal
...
```

NORMAL

```
4.2.1.1
Global Price
```

GLOBAL PRICE (all beverages are given the same price level);

```
4.2.1.1
Global Price
P00      0.00
```

GLOBAL PRICE SETTING
By pressing the UP and DOWN keys and confirming with ENTER, it is possible to

choose the price level to associate to all beverages.

```
4.2.1.2
Single Prices
```

SINGLE PRICES (each beverage will be given a specific price level).

```
4.2.1.2
Single Prices
B01: P00  0.00
```

SINGLE PRICE SETTING
Enables selection of the price level to associate to each beverage. Select the beverage

to associate to a price using the UP and DOWN keys and confirm with ENTER, then select the price level (from 001 to 099) again with the UP and DOWN keys and confirm with ENTER.

```
4.2.2.
Differentiated 1
...
```

DIFFERENTIATED 1

```
4.2.2.1
Global Price
```

GLOBAL PRICE (all beverages are given the same price level);

```
4.2.2.1
Global Price
P00      0.00
```

GLOBAL PRICE SETTING
By pressing the UP and DOWN keys and confirming with ENTER, it is possible to

choose the price level to associate to all beverages.

```
4.2.2.2
Single Prices
```

SINGLE PRICES (each beverage will be given a specific price level).

```
4.2.2.2
Single Prices
B01: P00  0.00
```

SINGLE PRICE SETTING
Enables selection of the price level to associate to each beverage.

Select the beverage to associate to a price using the UP and DOWN keys and confirm with ENTER, then select the price level (from 001 to 099) again with the UP and DOWN keys and confirm with ENTER.

```
4.2.3.
Differentiated 2
...
```

DIFFERENTIATED 2

```
4.2.3.1
Global Price
```

GLOBAL PRICE (all beverages are given the same price level);

```
4.2.3.1
Global Price
P00      0.00
```

GLOBAL PRICE SETTING
By pressing the UP and DOWN keys and confirming with ENTER, it is possible to

choose the price level to associate to all beverages.

```
4.2.3.2
Single Prices
```

SINGLE PRICES (each beverage will be given a specific price level).

```
4.2.3.2
Single Prices
B01: P00  0.00
```

SINGLE PRICE SETTING
Enables selection of the price level to associate to each beverage.

Select the beverage to associate to a price using the UP and DOWN keys and confirm with ENTER, then select the price level (from 001 to 099) again with the UP and DOWN keys and confirm with ENTER.

```
4.2.4.
Card
...
```

CARD

This function enables the application of differentiated prices if the card is used for payment. By setting CARD PRICES = YES a new menu entry will appear in PRICE MANAGEMENT, enabling

```
4.2.4.1
Card Prices
No
```

setting the price level to be applied to the product (beverage or snack) if payment is made by card.

```
4.2.4.2
Global Price
```

GLOBAL PRICE (all beverages are given the same price level);

```
4.2.4.2
Global Price
P00      0.00
```

GLOBAL PRICE SETTING
By pressing the UP and DOWN keys and confirming with ENTER, it is possible to

choose the price level to associate to all beverages.

4.2.4.3
Single prices

SINGLE PRICES (each beverage will be given a specific price level).

4.2.4.3
Single prices
001: P00 0.00

SINGLE PRICE SETTING
Enables selection of the price level to associate to each beverage.

Select the beverage to associate to a price using the UP and DOWN keys and confirm with ENTER, then select the price level (from 001 to 099) again with the UP and DOWN keys and confirm with ENTER.

4.3.
Free
Mai

Free
Allows you to select if the beverages will be provided free-of-charge, upon payment,

or free-of-charge within a time range.

4.4.
Free on
1mmsvd 00:00

Free On/Off
Allows the beginning and end of the free-of-charge beverage supply to be set.

4.5.
Free off
1mmsvd 00:00

4.6.
Price Dif 1-On
1mmsvd 00:00

Diff Prices 1-On/Off
Allows the beginning and end of beverage supply with differentiated prices to be set.

4.7.
Price Dif 1-Off
1mmsvd 00:00

4.8.
Price Dif 2-On
1mmsvd 00:00

Diff Prices 2-On/Off
Allows the beginning and end of beverage supply with differentiated prices to be set.

4.9.
Price Dif 2-Off
1mmsvd 00:00

8.3 Maintenance menu

The structure of the maintenance menu is shown at 8.3.2. All entries present in the maintenance menu are described at 8.3.3.

8.3.1 Entering the maintenance menu



Open the door, disable the safety device (see 3.4) and press the **P2** key (Fig. 69) to enter the maintenance menu.

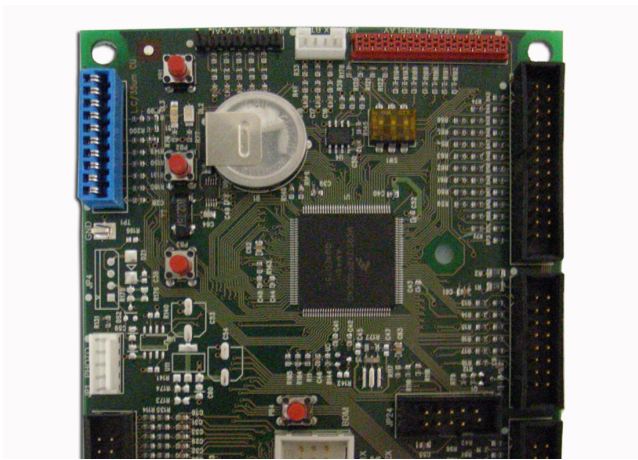

Fig. 69

To exit the maintenance menu and return to the standard operation of the vending machine:

- Press the CANCEL button repeatedly until "EXIT ?" appears. Select YES and press ENTER.
- remove the key from the safety switch in order to turn off the vending machine;
- close the door and wait for the self-configuration process to end.

8.3.2 Structure of the maintenance menu

1.	MAINTENANCE
1.1.	Actual Errors
1.2.	Error log
1.3.	STEP DOWN COUNTERS
1.3.1.	RESINS REGENERATION
1.3.2.	Reset
1.4.	Rinsing time
1.5.	TEST WATER/SOLUBLES
1.5.1.	Batcher1 Calib.
1.5.2.	Batcher2 Calib.
1.5.3.	EV Calib.
1.5.4.	Brewing Unit Calib.
1.6.	COOL DOWN BOILER
1.7.	DRAIN BOILER
1.8.	BOILER FILL
2.	STATISTICS
2.1.	Total sales
2.2.	OVERPAY
2.3.	CARD IN
2.4.	CARD OUT
2.5.	Totale coins
2.6.	Totale banknote
2.7.	Counters
2.8.	free
2.9.	TEST
2.10.	vmc CODE
2.11.	SLAVE VMC
2.12.	Reset

8.3.3 Description of messages in the maintenance menu

```
1.
Maintenance
    ...
```

MAINTENANCE

This function enables the display and cancellation of any errors that may be present. It is also possible to

carry out maintenance on the vending machine.

To reset the errors, use the menu under the maintenance item.

```
1.1.
Actual error
```

Error reset

This describes the current error (check the cause in section 11.2 - Error messages). If no error is present, this message

is not displayed.

After checking the error cause, press the ENTER key to reset the vending machine (see section 11.2 for the complete list of errors).

```
1.2.
Error log
```

Error log

VM's EEPROM records the important events that occur in the VMC (for example errors that occurred, warning messages, etc.).

Recording takes place when the error condition is detected and consists of saving the following information:

- 1- error code (or warning code) occurred;
- 2- location of signal source (e.g., which spiral motor, if the error is due to a spiral motor, or which coffee or instant product);
- 3- day, month, hour and minute of error detection (this information is available only if the VM is equipped with a timekeeper).

The recordings are included in a list which may contain up to 50 elements; when this limit is exceeded the information is input again starting from position 1 (previous information will be lost).

Note

All errors or faults are stored, except when blocks occur (coffee, instant product, beverage, water).

Display:

```
1.1
ERROR LOG ii/NN
dd MMM hh:mm
Exx - aabb
```

Format of warning error description recorded in LOG:

Exx	WHAT ==>	xx code error/warning alarm
aabb	WHERE ==>	if Myy = spiral motor yy
aabb	WHERE ==>	if Syy = yy instant product dispensing
aabb	WHERE ==>	if Lyy = yy instant product rinsing
aabb	WHERE ==>	if C — = coffee brewing
aabb	WHERE ==>	if aabb = hexadecimal codes
ddmmm	WHEN ==>	day in figures, month in string (3 letters)
hh:mm	WHEN ==>	hour:minutes
ii		error index in LOG
NN		number of errors in LOG

```
1.3.
Step down counters
```

Step down counters

```
1.3.1.
Resins regeneration
```

RESINS REGENERATION
Allows the use of the water filter to be checked.

```
1.3.2.
Reset
```

RESET
Select YES to indicate a new filter has been installed. This operation returns "Remaining Qty" to the same value as "Filter Limit" and the date in the "Last Filter Change" is changed to today's date.

```
1.4.
Rinsing time
```

Rinsing time

Enables rinsing of the instant product brewing circuits. By pressing the ENTER key the automatic cycle starts, thus activating each instant product circuit in sequence.

```
1.5.
Test water/solubles
```

Test Water/Solubles

Allows some calibration operations to set up the machine.

```
1.5.1.
Batcher1 calib.
```

BATCHER1 CALIB.

Allows checking the quantity of powder dispensed by dosing unit 1.

To carry out the check, you must:

- 1- remove the brew group
- 2- prepare a container (e.g. a cup) to collect the coffee powder
- 3- Select "Yes" from the menu, the machine grinds a coffee dose and discharges it
- 4- check if the weight of the resulting dose corresponds to what expected, otherwise adjust the dosing unit as shown in section 7.4

1.5.2.
Batcher2 calib.

BATCHER2 CALIB.
Allows checking the quantity of powder dispensed by dosing unit 2.

To carry out the check, you must:

- 1- remove the brew group
- 2- prepare a container (e.g. a cup) to collect the coffee powder
- 3- Select "Yes" from the menu, the machine grinds a coffee dose and discharges it
- 4- check if the weight of the resulting dose corresponds to what expected, otherwise adjust the dosing unit as shown in section 7.4

1.5.3.
EV calib.

EV CALIB.
Allows selecting one of the solenoid valves on the vending machine and activating it for

10 seconds, in order to check the flow (Flow adjustment is described in section 7.6).

1.5.4.
Brewing unit calib.

BREWING UNIT CALIB.
Allows handling the coffee brew group.

1.6.
Cool down boiler

Cool down boiler
Allows quick cooling of the boiler. By selecting the item "BOILER COOLING" the VM

dispenses water until the temperature detected by the sensor placed on the boiler has fallen below 50°C.

A coloured bar on the display indicates the current temperature of the boiler. When the bar disappears the temperature detected is less than 50° and the cooling down operation is completed; the VMC must be turned off.

1.7.
Drain boiler

Drain boiler
It enables start-up of the automatic discharge cycle of the boiler.

1.8.
Boiler fill

Boiler fill
Allows you to automatically fill the coffee boiler with water. Repeat the cycle until

the boiler is full (until water is dispensed from the coffee nozzle).

2.
Statistic

STATISTICS

...

2.1.
Total sales

Total sales
The total revenue from the sales of all selections and beverages is displayed.

By pressing [ENTER] it is possible to obtain detailed information of this revenue for:

- beverages (further divided according to price level, if required)
- cups sold
- discounts and increases made

2.8.
Overpay

Overpay

The amount of credit collected when the OVERPAY time has elapsed is displayed.

2.6.
Card in

Card-In

The amount of credit collected from cards is displayed.

2.7.
Card out

Card-Out

The amount of credit charged on cards is displayed.

2.5.
Total Coins

Total coins

The total value of the coins inserted is displayed.

2.4.
Total Banknote

Total banknotes

The total value of the banknotes inserted is displayed.

By pressing [ENTER] it is possible to display the number of banknotes inserted according to their denomination.

2.9.
Counters

Counters

The presence of the Timekeeper in this menu allows the extension of the quantity of information displayed. It is possible to display the total and partial number of beverages divided into price bands.

2.10.
Free

Free

The total number of free beverages dispensed is displayed.

2.11.
Test

Test

The total number of test beverages dispensed is displayed.

2.12.
VMC Code

VM Code

Assigned by the manufacturer.

2.9.
Slave VMC

VMC Slave

The amount of sales made by the Slave is displayed.

2.2.
Reset

Reset

Allows resetting the statistical data.

8.4 Machine Ready/Free Button

Open the door, exclude the safety device (see section 3.4), and press button **P3** (Fig. 70).

If pressed during the initial warm-up, this button allows inducing the "MACHINE READY" status before the boilers reach their set temperature.

If pressed after the "MACHINE READY" status is reached, this button allows dispensing a free product (this function can be enabled from the menu 1.18 "FREE BUTTON").

8.5 Reset

Open the door, exclude the safety device (see section 3.4), and press the button **P4** (Fig. 70) to restart the vending machine management programme.

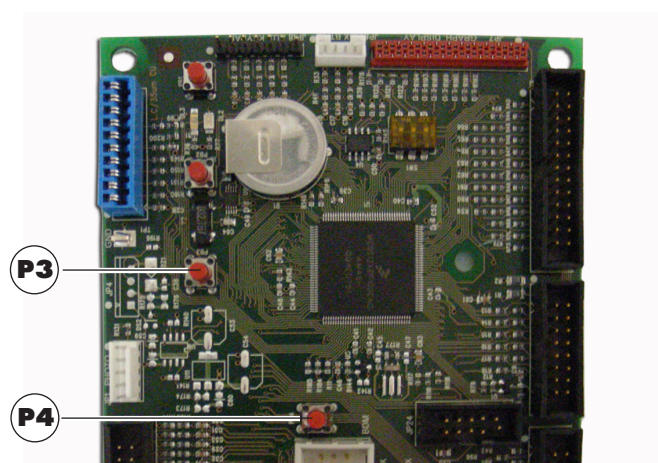

Fig. 70

9 OPERATION AND USE



Important

This appliance is not intended for use by persons (including children) with reduced physical, sensory or mental capabilities, or lack of experience and knowledge, unless they have been given supervision or instruction concerning use of the appliance by a person responsible for their safety.

9.1 Beverage selection



The **Atlante** vending machine can dispense 54 beverages.

The following are the conditions necessary to select a beverage:

- the vending machine has reached the set temperature after the start-up. Otherwise, once a beverage key is pressed, the display shows the message "HEATING";

- the credit available is sufficient or the vending machine has been set in free mode. If this is not the case, the display shows the message "INSERT XXX";
- there is no error condition that prevents the dispensing of beverages. If this is not the case, the display shows the error message "OS BEVERAGES XXX" alternated with "NOT AVAILABLE";
- the beverage selected is enabled. If this is not the case, the message "NOT AVAILABLE" will be displayed;
- there is no block condition for the beverage selected. If this is not the case, the message "BEVERAGE XXX" alternated with "NOT AVAILABLE" is displayed before the key is pressed. After the key is pressed, the display shows the message "NOT AVAILABLE";
- the dispensing outlet door is closed. If this is not the case, the display shows the message "CLOSE SERVICE DOOR".



Important

The brewing cycle cannot be interrupted by the dispensing outlet door open, until cup, sugar and stirrer loading is complete.

If the door is opened accidentally, it should be closed and the beverage brewing will continue automatically.

During the brewing of a beverage:

- payment systems are disabled;
- the first line on the display shows the programmable dispensing message (default message is: "WAIT FOR PRODUCT").

Beverage selection

If the vending machine is not set to dispense free beverages, insert the credit required.

Press the key corresponding to the beverage required.

When the beverage is dispensed, the message "REMOVE CUP" is displayed. Take the beverage out of the dispensing outlet.

After closing the door the display will show the message "THANK YOU" and after a few seconds "ATLANTE" (the vending machine is awaiting selection).



Warning

To avoid scalding, wait for the end of brewing signal (the message "REMOVE CUP" will appear on the display) before placing your hand in the dispensing outlet.

Do not open the dispensing outlet door while the vending machine is brewing.

In case of failures or product missing during the brewing phase, a message indicating the cause of this stop will appear on the display.

Messages and special warnings are listed in section 11.

10 CLEANING AND MAINTENANCE



Warning

Unplug the power cord before performing any cleaning and/or maintenance operation.

It is prohibited to perform cleaning or maintenance operations on the internal components of the vending machine with the safety microswitch disabling key inserted.

The Manufacturer declines any liability for any damage or malfunctioning caused by incorrect or poor maintenance.



Important

During the loading operations do not stress any of the live electrical parts and do not clean them with damp cloths.



Warning

Avoid using chlorine-based tablets so as to prevent oxidation phenomena inside the vending machine.

10.1 General notes for correct operation



The vending machine and its non-removable components must be cleaned using non-abrasive sponges or damp cloths.

Do not direct water jets on the components and/or on the vending machine.

Check for correct brewing of beverages and adjust the grinding when necessary.

To guarantee the correct operation of the vending machine it is recommended to conform to the instructions and times indicated in the MAINTENANCE SCHEDULE (see 10.2.1).

10.2 Cleaning and scheduled maintenance



Warning

All components must be rinsed with warm water only, without using any detergent or solvent that could modify their form and operation.

Removable components cannot be rinsed in the dishwasher.

During the cleaning and maintenance operations do not stress the following electrical components: CPU card; starter port; interconnection port.

Do not clean the above mentioned electrical components using damp cloths and/or degreasing detergents. Remove dust residues with a jet of dried compressed air or using an antistatic cloth.

10.2.1 Maintenance schedule



Daily

Use a damp cloth with detergents suitable for cleaning products in contact with food:

- the display (2 - Fig. 1);
- the "instructions for use" label (6 - Fig. 1);
- the beverage dispensing outlet (7 - Fig. 1);
- the keypad (3 - Fig. 1).

Weekly

- Clean the drip tray (see 10.2.2).
- Replace the coffee grounds bag (see 10.2.3).
- Empty the fluid discharge tank and wash it (see 10.2.4).
- Clean the stirrer channel (see 10.2.12).
- Clean the coffee bean brew group and the coffee ground channel (see 10.2.5).
- Clean the mixer and dispenser of the instant products (see 10.2.6).
- Clean the dispensing outlet (see 10.2.7).

At each supply

- If necessary, clean the coffee bean, instant product and sugar containers (see 10.2.8).

Monthly

- Remove the components of the dispensing outlet and wash them carefully (see 10.2.7).
- Clean the dispensing arm (see 10.2.9).
- Clean the coffee grinder (see 10.2.10).

10.2.2 Drip tray cleaning



Unscrew the knob, remove, open and thoroughly clean the drip tray (Fig. 71).

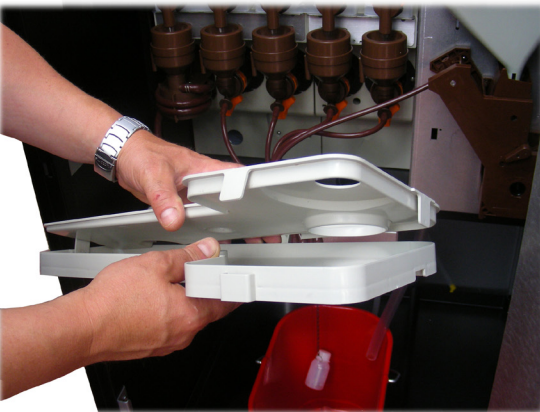
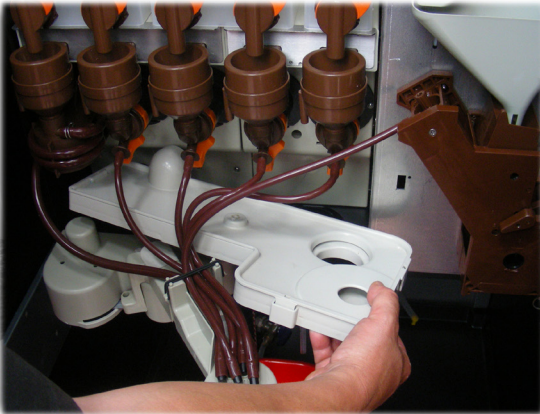

Fig. 71



Warning

Make sure the surface is clean when repositioning the drip tray.

10.2.3 Replacement of the coffee ground bag



Tighten the clip, extract the full bag and replace it with a new one (Fig. 72).



Fig. 72

10.2.4 Emptying the fluid discharge tank



Remove the tank from the vending machine (Fig. 73).



Fig. 73

Wash the tank, then replace it inside the machine.

10.2.5 Cleaning of the coffee brew group



Disconnect the hose from the dispensing arm (Fig. 74).



Fig. 74

Remove the brew group keeping the lever in **3** position (Fig. 75 and 76).

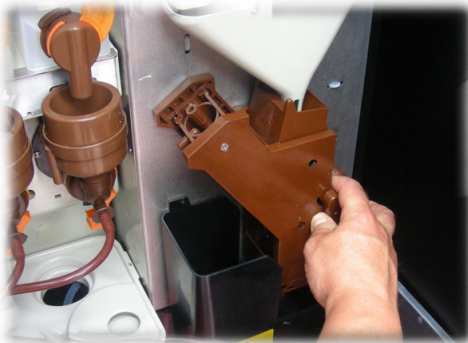

Fig. 75

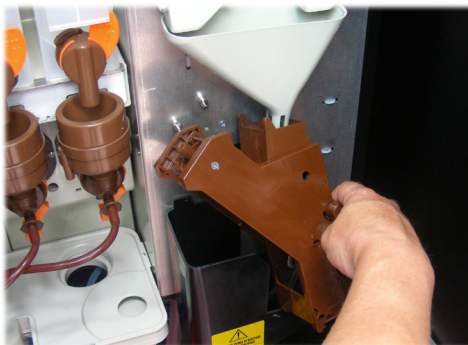

Fig. 76

Wash the brew group with lukewarm water and clean the upper filter carefully (Fig. 77).

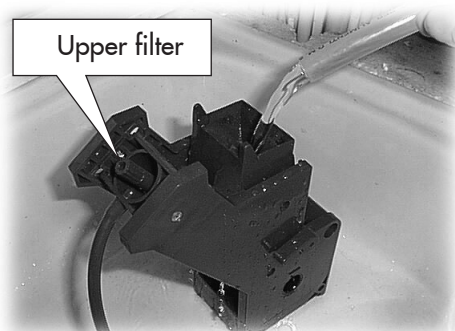

Fig. 77

Important

When inserting the brewing group, make sure that the reference arrows are aligned. If this is not the case, align them using the key provided.

Lift and remove the coffee ground channel (Fig. 78) and wash it with lukewarm water.



Fig. 78

10.2.6 Cleaning the instant product dispenser and the mixer



Disconnect the dispensing hose from the nozzle and from the dispensing arm (Fig. 79).

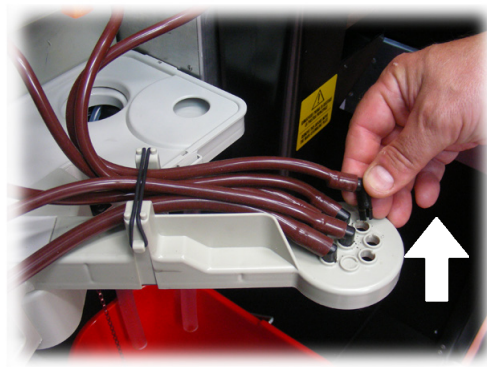
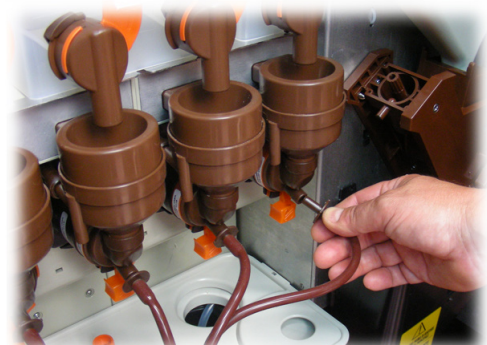

Fig. 79

Remove the cover and the instant product funnel (Fig. 80).

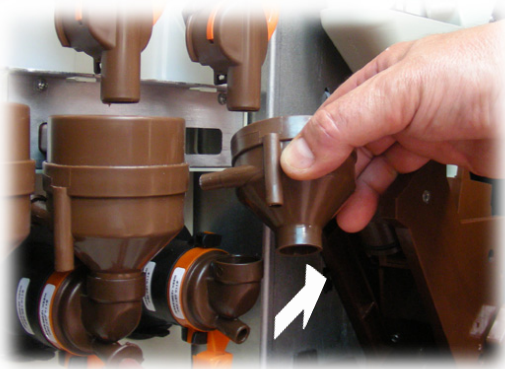

Fig. 80

Turn the blocking ring clockwise (Fig. 81) and remove the mixer body.

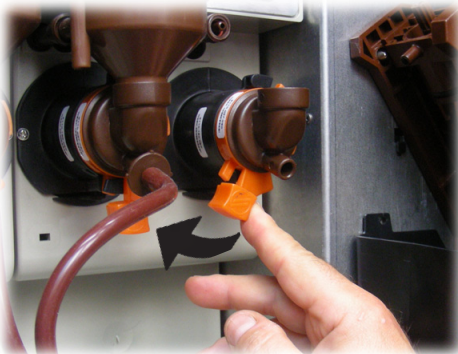

Fig. 81

Remove the fan by levering carefully with a flat screwdriver (Fig. 82).

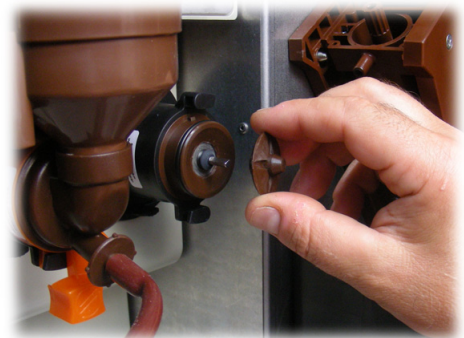

Fig. 82

Wash all components with lukewarm water and pay particular attention not to damage the fan.

Assemble the components in reverse order and connect the dispensing hose correctly.

10.2.7 Cleaning the dispensing outlet



Operate on the dispensing outlet locking lever (Fig. 83).



Fig. 83

Remove the dispensing outlet (Fig. 84).

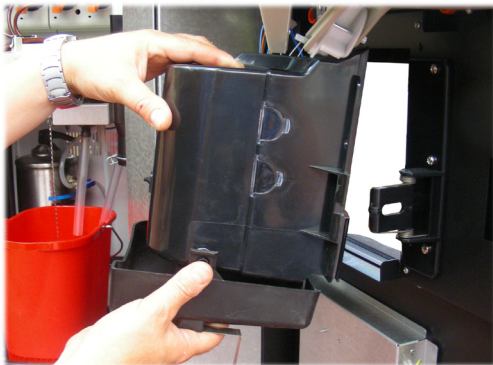

Fig. 84

Remove the lower plate from the dispensing outlet and wash it thoroughly with lukewarm water (Fig. 85).

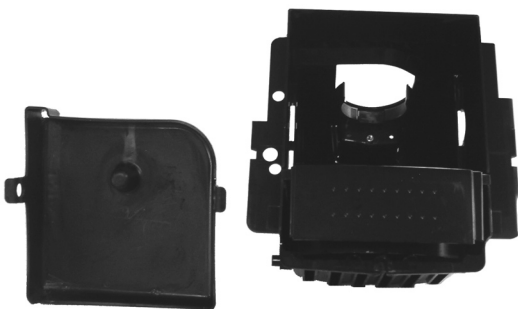

Fig. 85

Reassemble the lower plate onto the dispensing outlet only when they are completely dry.

Assemble the components in reverse order.

10.2.8 Cleaning the containers



To clean the coffee bean hopper the following operations are necessary:

- push the moving panel inward (Fig. 86);
- dispense a few test coffee cups in order to empty the coffee grinder from coffee beans;
- lift the container up and remove the bean residues using an aspirator;
- wash the inside of the container and dry it carefully before reassembling it.



Fig. 86

The following operations are necessary to clean the instant product container:

- turn the container locking lever clockwise (Fig. 87);



Fig. 87

- remove the container (fig. 88) by pushing it towards the inside of the vending machine in order to release the lock (A), then push it upwards



Fig. 88



- wash the inside of the container and dry it carefully before reassembling it.
- to reassemble the container, follow the same procedure in reverse order, paying attention to insert the lock (A) into the appropriate slot.

The following operations are necessary to clean the sugar container:

- turn the container locking lever clockwise (Fig. 89);

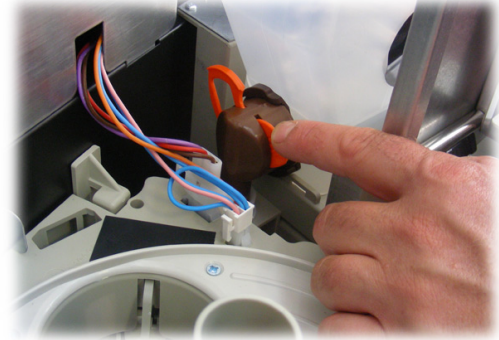

Fig. 89

- remove the container (Fig. 90);



Fig. 90

- wash the inside of the container and dry it carefully before reassembling it;
- replace the container taking care to insert the nozzle into the coupling (Fig. 91).

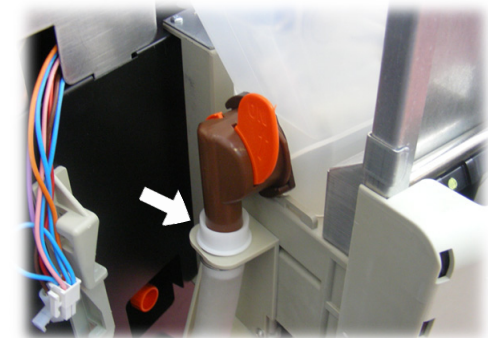

Fig. 91

10.2.9 Cleaning the dispensing arm



Remove the elastic which blocks the hoses (Fig. 92).



Fig. 92

Disconnect the hoses from the dispensing arm (Fig. 93).

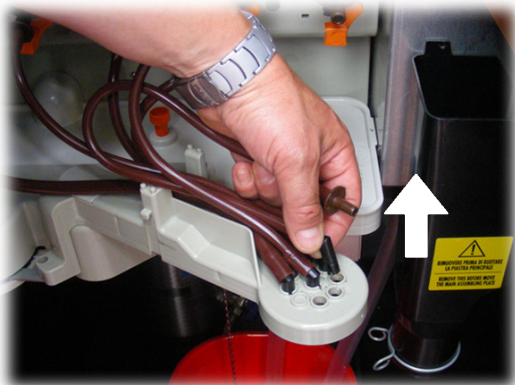

Fig. 93

Remove the brewing unit (Fig. 94).



Fig. 94

Wash the components in lukewarm water and assemble in reverse order.

10.2.10 Cleaning the coffee grinder



Each month, clean the coffee grinder of any residues that might lead to deposits.

After removing the coffee bean hopper (10.2.8 - Fig. 86), clean the coffee grinder carefully with an aspirator.

10.2.11 Cleaning the sugar dispensing channel



- Unscrew the knurled pin to remove the movable sugar chute from the support (Fig. 95);



Fig. 95

- Unfasten the screw fixing the movable sugar chute to the connecting rod (Fig. 96).



Fig. 96

Wash the movable sugar chute in lukewarm water and assemble in reverse order.

10.2.12 Cleaning the stirrer channel



Remove the stirrer channel (Fig. 97).

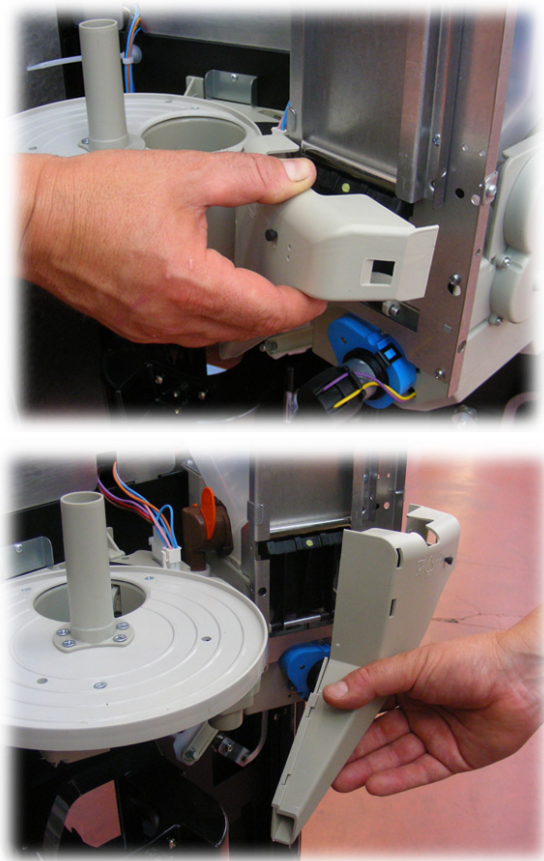

Fig. 97

Wash the stirrer channel in lukewarm water and assemble in reverse order.

10.3 Non-scheduled maintenance



The vending machine is equipped with an assembly plate containing most of the vending machine components (Coffee grinder, Gear motor, Mixer, Instant product motors, Pump, Turbine and De-humidifier).

To access one of these components, do not remove the instant products and coffee containers, but simply pull the retainer downwards (Fig. 98 ref **A**) and turn the surface clockwise up to 180° (Fig 99 - 100).

It is now possible to access all the plate's mechanical components.

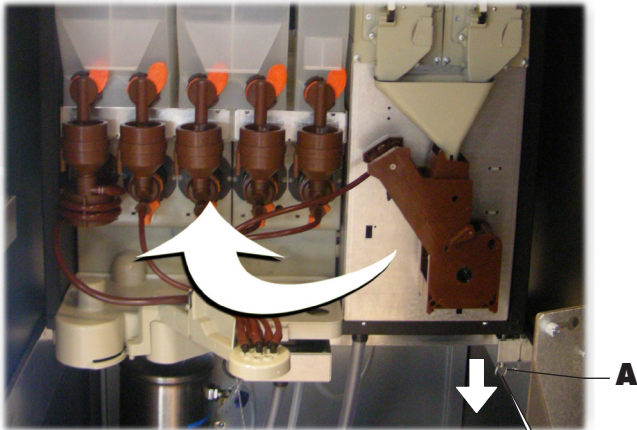

Fig. 98

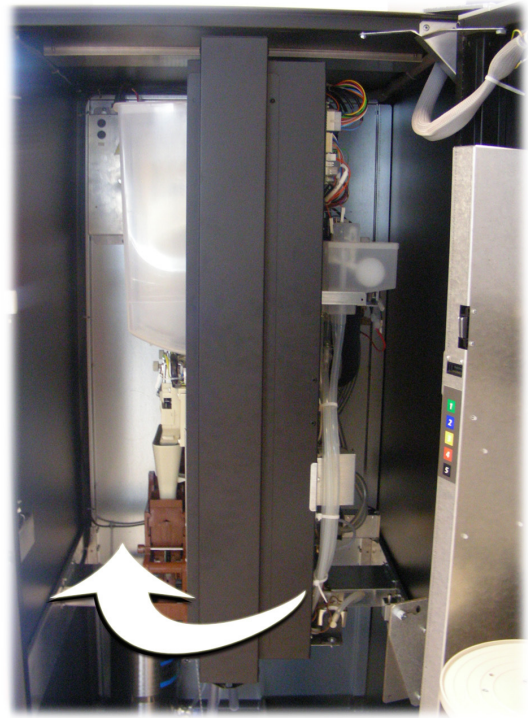
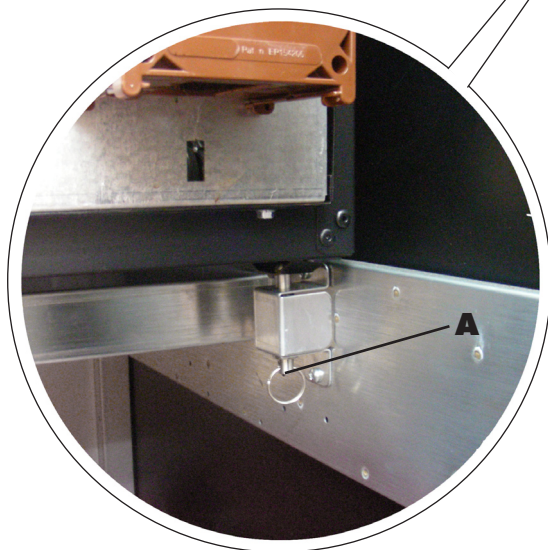

Fig. 99

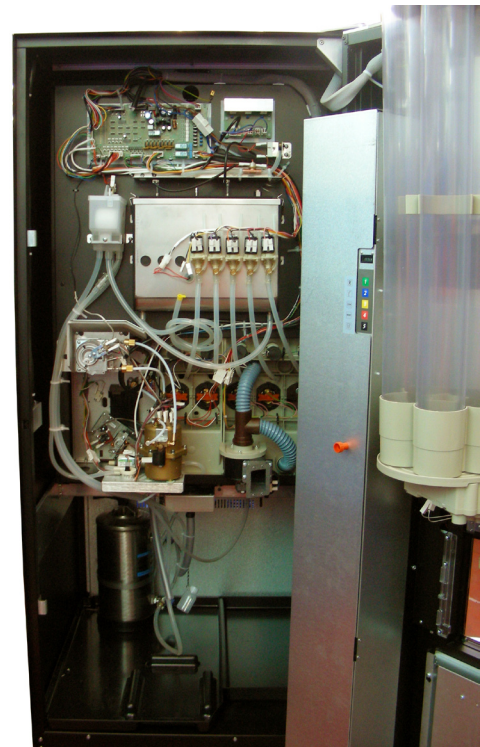

Fig. 100



Important

Remove the coffee ground channel before turning the surface (point 10.2.5 - Fig. 78).

10.4 Software update



The vending machine management programme is stored in the flash memory included in the "Freescale MC9S12XEP100" microcontroller.

The software update can be performed by using:

- A "VDRIVE2" module (Fig. 101);
- The interface circuit;
- A USB key (Pen Drive);
- A file containing the new software to be loaded.



Fig. 101

Update procedure:

- Store the "SAE_650M.s19" file on a USB key* (file should be stored on the device root);
- Switch off the vending machine;
- Insert the USB key into the VDRIVE2;
- Connect the VDRIVE2 wiring to the interface circuit (Fig. 102);



Fig. 102

* All common USB keys used on PCs are suitable. Some restrictions are:

- The device has to be FAT12, FAT16 or FAT32 formatted
- The sector size has to be of 512 Bytes

- Insert the interface circuit into the blue connector of the CPU board (JP2) (Fig. 103);



Fig. 103

- Press and hold the P1 button (Fig. 103) on the CPU;
- Switch on the vending machine;
- After a CPU beep** release the P1 button;
- 3 close beeps and the restart of the vending machine confirm that the software has been updated.
- Switch off the vending machine;
- Remove the VDRIVE and the interface circuit.

**The software update request is notified by the CPU beep. The file search procedure and the following recording on the microcontroller is performed according to the following steps:

- The CPU recognises the USB key and searches for the file with the software to be loaded (green and red lights on the CPU flash alternatively);
- Once the correct file has been recognised the software is loaded on the CPU (only the green light flashes for approximately 1 minute);
- 3 close beeps and the restart of the vending machine confirm that the software has been updated.
- In case of errors, a long beep is emitted and the red light stays on.

11 DISPLAY MESSAGES

This section shows the display messages:

- during standard operation;
- in case of a fault (error messages).

11.1 Messages during operation

The table below shows a list of messages displayed during the standard operation.

Cod. errore	Messaggio	Cause	Rimedio
/	SAECO ATLANTE	The vending machine is in stand-by.	
/	WAIT FOR PRODUCT	Product dispensing in progress.	
/	CLOSE DOOR	Dispensing outlet door open.	Close the door
/	SUGAR 1-x SUGAR 2-xx SUGAR 3-xxxxx SUGAR 4-xxxxxxx	SUGAR QUANTITY to be dispensed with the beverage.	
/	PRESELECTION xx-xx	Preselection of the second or third set of beverages activated.	
/	CAFFEE NOT AVAILABLE	The coffee beans hopper is empty.	Carry out the supply (see section 7).
/	NOT AVAILABLE	A Type of product not available.	
/	NO CHANGE AVAILABLE	The level of coin stacking tubes is below the preset limit.	Add coins into the change-giving coiner.
/	NO LINK	No dialogue with the selected payment system is detected by the VM.	Check for dialogue with the payment system.

11.2 Error messages

During operation the vending machine is able to detect a series of faults that may lead to a full or partial blockage of its functions. In case of total blockage, the first line on the display will show the out-of-service message, while the second line will display the fault code; an example is given:

CALL FOR ASSISTANCE
OUT OF SERVICE 25

FAILURE CODE

In this case the vending machine is out of service. To bring it back into working order again, it is necessary to remove the cause of the fault and possibly carry out the error reset procedure described at 8.3.3.

Cause	Code	Registered in ERROR LOG as error or warning	Effect	Automatic reset at restarting	Error resettable from 5-key keypad	Check the „health“ status of the VMC using the VMC or refer to the loader (using reset on the 5 key keypad)
water level low in air break	1	E/W	blocked	YES	YES	VMC
no coffee dosing unit level detected (coffee not available?)	2	E	coffee blocked	YES	YES	Loader
no movement of group gearmotor detected	3	E	coffee blocked	YES	YES	VMC
no movement of group gearmotor detected	4	E	coffee blocked	YES	YES	VMC
no flowmeter pulses detected	5	E	coffee blocked	YES	YES	Loader
no movement of dispensing arm detected	6	E	blocked	YES	YES	VMC
drip tank full	9	E	blocked	YES	YES	VMC
no movement of cup release detected	10	E/W	see CupManagement sheet	YES	YES	VMC
no movement of stirrer ejector detected	11	E	blocked	YES	YES	VMC
reading of temperature sensor out of range	13	E	instant product stopped	YES	YES	VMC
reading of coffee temperature sensor out of range	14	E	coffee blocked	YES	YES	VMC
e2prom corrupted	16	E	blocked	YES	YES	VMC
no movement of cup holder detected	17	E	see CupManagement sheet	YES	YES	VMC
no brew group detected	20	E	coffee blocked	YES	YES	VMC
abnormal flow detected in coffee brewing	22	E	coffee blocked	NO	YES	Loader
pump timeout	23	w	message only	YES	YES	VMC
no instant product boiler level detected	24	E	blocked	YES	YES	VMC
setting of decimal point position detected not consistent with payment system	31	E	blocked	–	YES	VMC
credit management restarting message	32	E	message only	–	YES	–
pressing of CPU P3 key for 15 seconds detected	33		blocked	NO	YES	VMC
MDB slave error detected	35	E	blocked	–	YES	VMC
coffee boiler heating slow	36	E	coffee blocked	YES	YES	VMC
instant product boiler heating slow	37	E	instant product stopped	YES	YES	VMC
Credit management restart	42	W	message only	–	–	–
watchdog intervention	72	W	message only	–	–	–
change-giving coiner error message	80	E	error log	–	–	–
Filter countdown for water softener resin regeneration has run down.	83	W	error log	NO	NO	–
No coffee in container 1	90	E	coffee blocked 1	NO	YES	Loader
No coffee in container 2	91	E	coffee blocked 2	NO	YES	Loader
Steam temperature sensor out of range	92	E	stop preheat + error log	YES	YES	VMC
both of the boilers out of use	93	E	blocked	YES	YES	VMC
steam boiler heating time too long detected	94	E	stop preheat + error log	YES	YES	VMC
coffee boiler filling time too long detected	95	E	coffee blocked	YES	YES	VMC

12 STORAGE - DISPOSAL

12.1 Change of location



Should the vending machine be positioned in another site it is necessary to carry out the following operations:

- unplug the vending machine;
- empty the instant product, coffee bean and sugar containers;
- empty the instant product boiler and the AIR BREAK. Remove the pipe cap (Fig. 104) and channel the water into a container. After draining the pipe completely, fit the cap back into its original position;

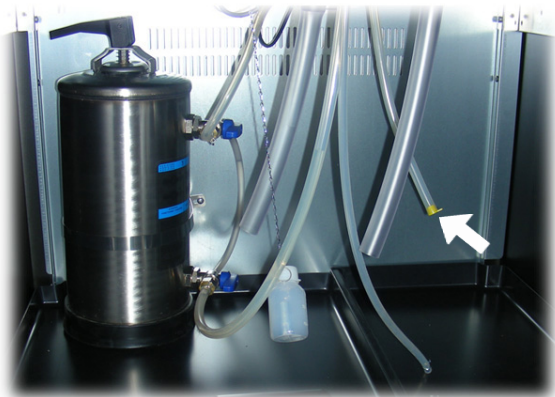

Fig. 104

- drain the water pipe. Remove the spring from the pipe (Fig. 105) and channel the water into a container. After draining the pipe completely, fit the spring back into its original position;

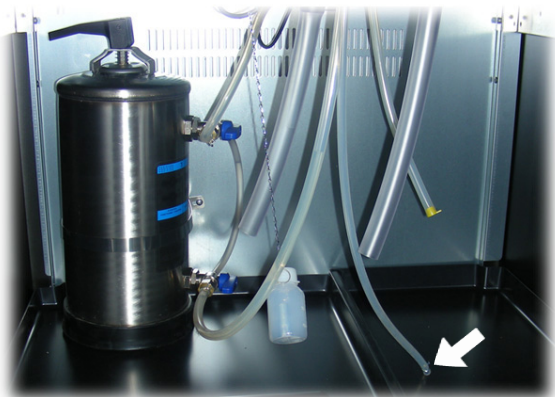

Fig. 105

- empty the coffee grounds bag (see 10.2.3);
- empty the fluid discharge tank and wash it (see 10.2.4);
- clean the vending machine as indicated in section 10;
- put the components back in place and close the doors;
- lift and position the vending machine in the site chosen as indicated at 5.2.

12.2 Inactivity and storage periods

If the vending machine needs to be stored or remains inactive for a long period, it is necessary to carry out the same operations as described at 12.1:

- wrap the vending machine in a tarpaulin to protect it from dust and damp;
- check that the vending machine is in a suitable place (the temperature should not be less than 1°C) taking care not to place any boxes or appliances over it.

13 INSTRUCTIONS FOR END-OF-LIFE DISPOSAL TREATMENT

This product complies with EU Directive 2002/96/EC.



The symbol  on the product or on its packaging indicates that this product may not be treated as household waste. Instead it shall be handed over to the applicable collection point for the recycling of electrical and electronic equipment.

By ensuring this product is disposed of correctly, you will help prevent potential negative consequences for the environment and human health, which could otherwise be caused by inappropriate waste handling of this product. For more detailed information about recycling of this product, please contact your local city office, your household waste disposal service or the shop where you purchased the product.



Warning

The disposal of the vending machine or of a part of it must be carried out with full respect of the environment and according to local laws in force.

